

Einspeise-, Abgangsfeld IZM32 Festeinbau 3200A ungl. S. incoming-, outgoing unit IZM32 fix 3200A OPPO

Aufbau Feld / installation field

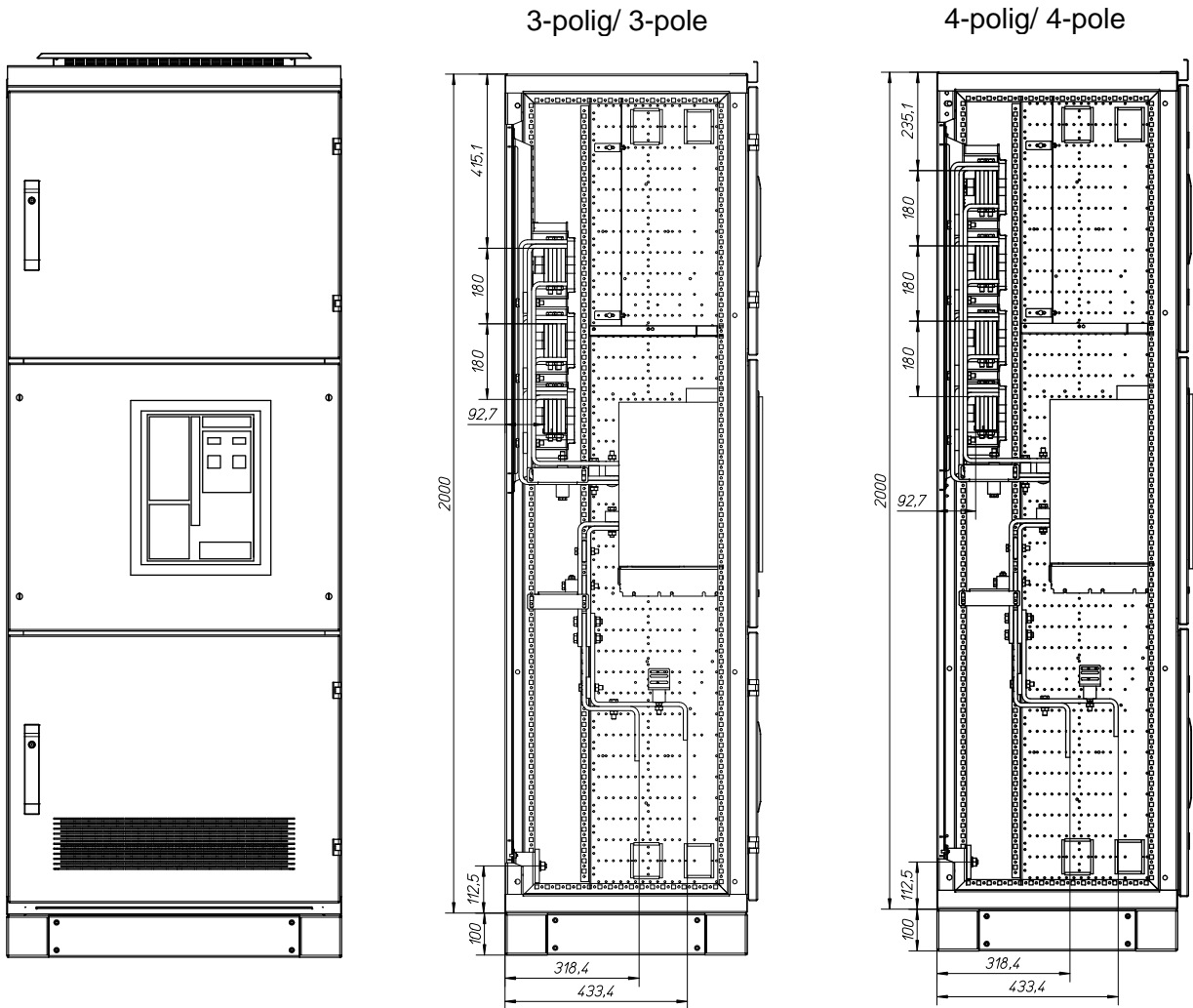

xEnergy Feld / field 2000x600/800x600/800

Einbausatz / mounting kit: IZM32
IZM32

Bemessungsstrom / Current Rating (I): 3200A

Material der Cu-Schienen / busbar material: EN 13601-Cu-ETP-R250
(ersetzt / replaced: DIN 40500 / 46433 E-Cu 57, F25)

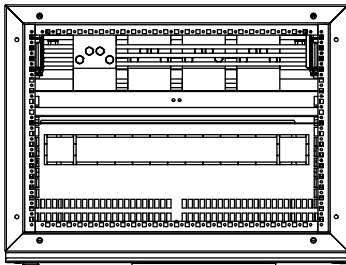

Hinweis / note:
Kupferaufbau kann horizontal gespiegelt werden!
Copper construction can be mounted upside down!

Einspeise-, Abgangsfeld IZM32 Festeinbau 3200A ungl. S. incoming-, outgoing unit IZM32 fix 3200A OPPO

Eingangsschienenverbindung / incoming connection

3-polig / 3-pole

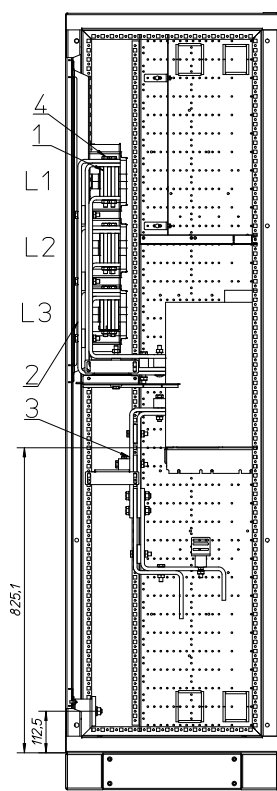
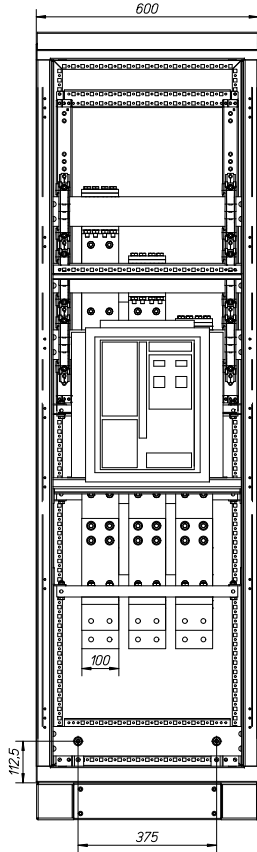

4-polig / 4-pole

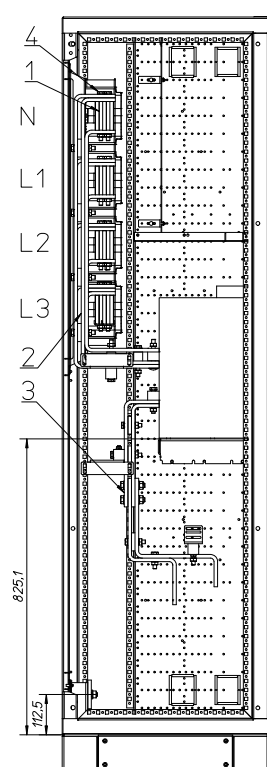
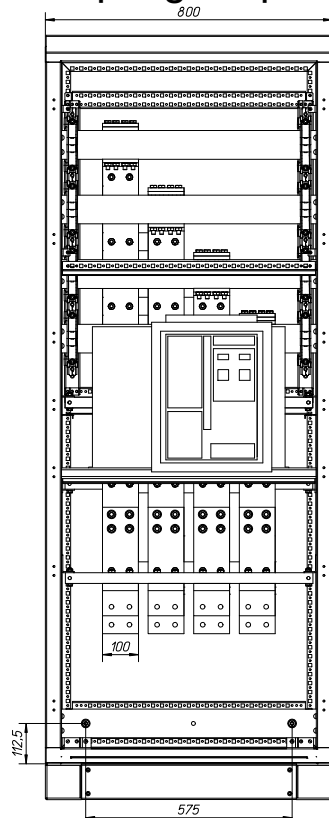

Einspeise-, Abgangsfeld IZM32 Festeinbau 3200A ungl. S. incoming-, outgoing unit IZM32 fix 3200A OPPO

Anschluss Schalter - Gesamtansicht / switch connection - overview

Pos. no.	Benennung name	Beschreibung specification	Montagematerial/Zubehör Installation material/ comonents
1	Hauptsammelschiene main busbar		
2	Abgangssammelschiene outgoing busbar	3x100x10 mm	Blatt 8-14 Page 8-14
3	Eingangssammelschiene incoming busbar	2x100x10 mm	Blatt 4-7 Page 4-7
4	Sammelschienenverbindung busbar connection		Blatt 8-14 Page 8-14

3-polig / 3-pole

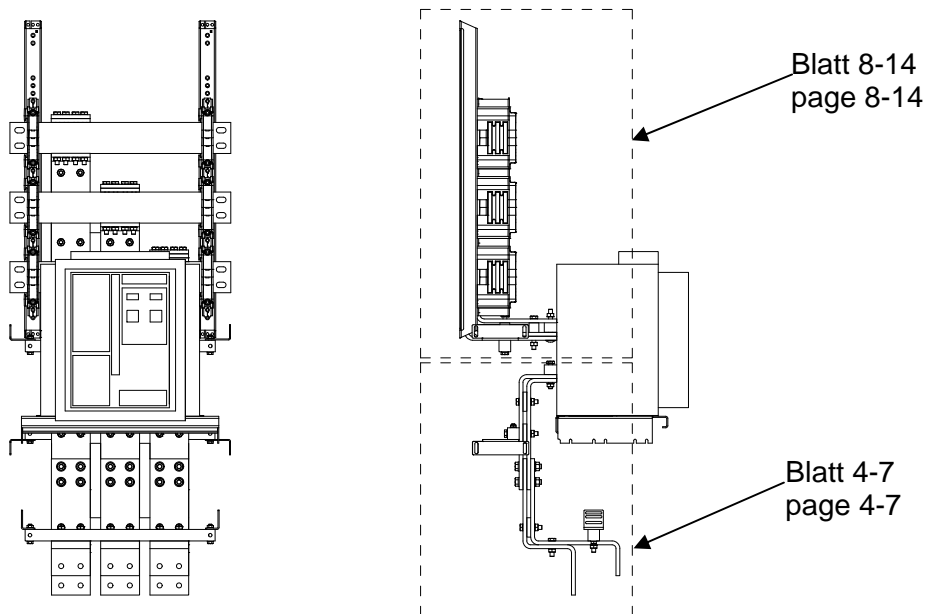

4-polig / 4-pole

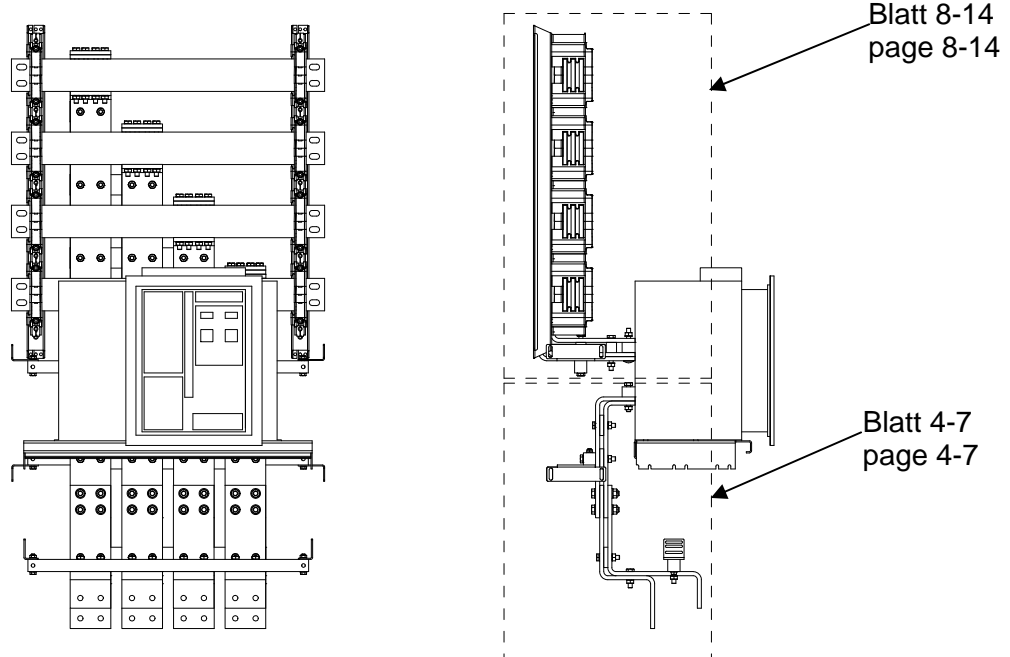

Einspeise-, Abgangsfeld IZM32 Festeinbau 3200A ungl. S. incoming-, outgoing unit IZM32 fix 3200A OPPO

Eingangsschienenverbindung / incoming connection

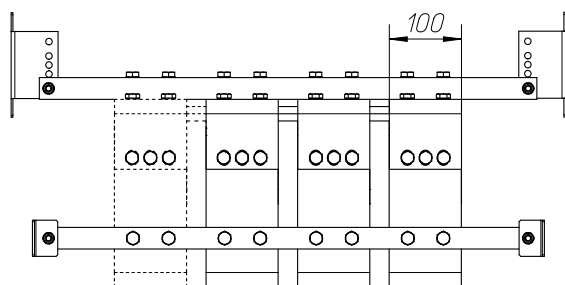
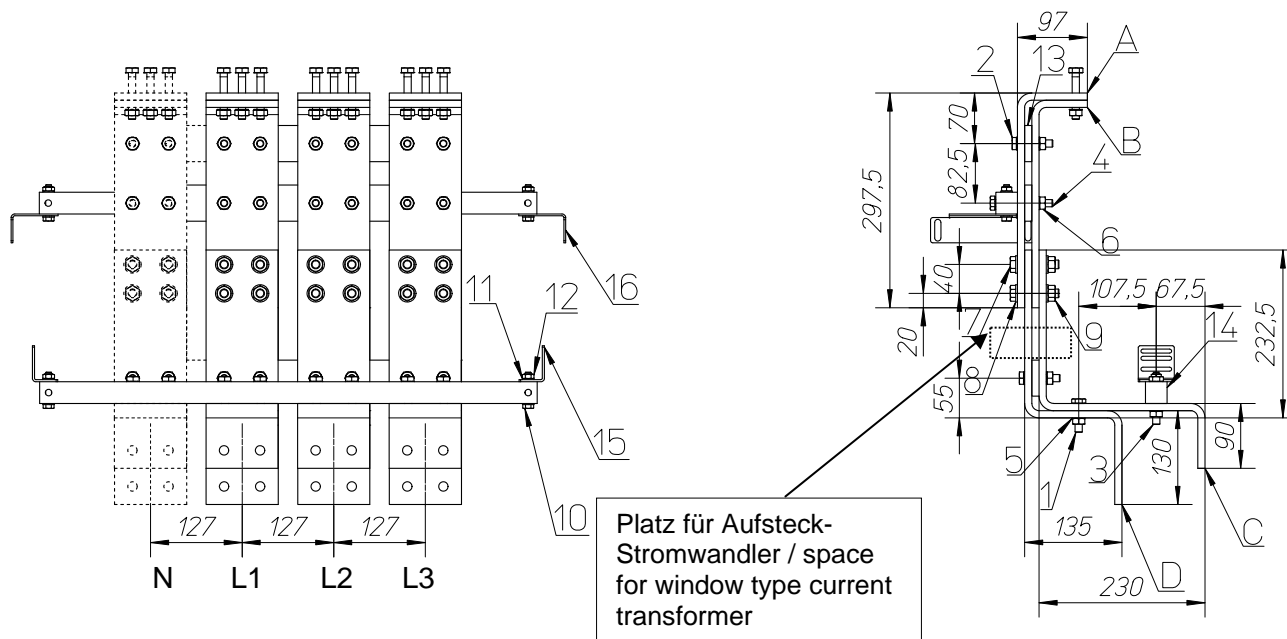

Kupfer / copper 100mm x 10mm
Gestreckte Längen* / flat length*

Schiene busbar	Gestreckte Länge N flat length N	Gestreckte Länge L1 flat length L1	Gestreckte Länge L2 flat length L2	Gestreckte Länge L3 flat length L3
A	377,9mm	377,9mm	377,9mm	377,9mm
B	347,9mm	347,9mm	347,9mm	347,9mm
C	509,3mm	509,3mm	509,3mm	509,3mm
D	464,3mm	464,3mm	464,3mm	464,3mm

*Radius R10

Biegeverkürzung / correction factor: +3,4mm

Einspeise-, Abgangsfeld IZM32 Festeinbau 3200A ungl. S. incoming-, outgoing unit IZM32 fix 3200A OPPO

Eingangsschienenverbindung / incoming connection

Pos. / No. 13

Stabilisator
stabilizer
50x10x481 / 354(3P)

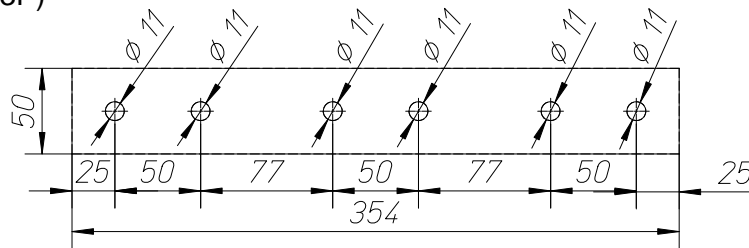
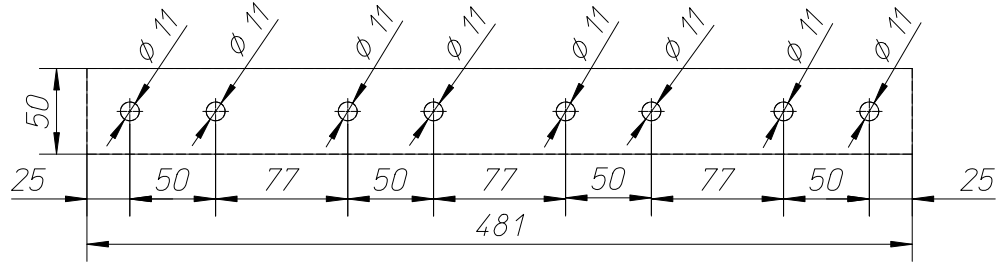

Pos. / No. 14

Stabilisator
stabilizer
30x30x690 / 490(3P)

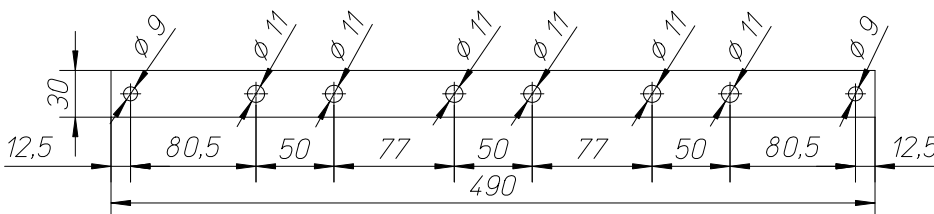
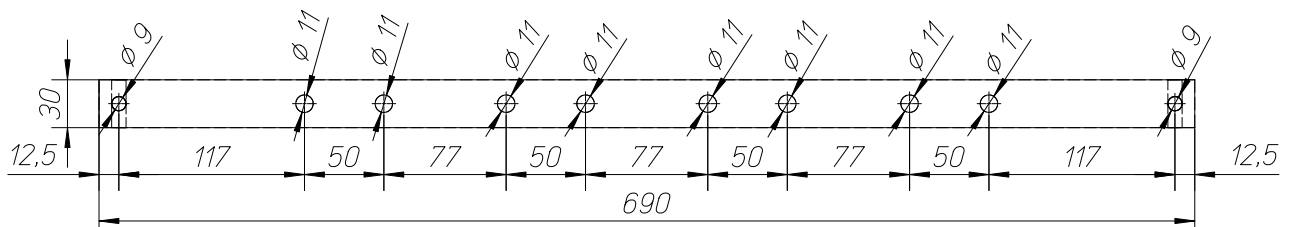

Einspeise-, Abgangsfeld IZM32 Festeinbau 3200A ungl. S. incoming-, outgoing unit IZM32 fix 3200A OPPO

Gestreckte Längen / flat length

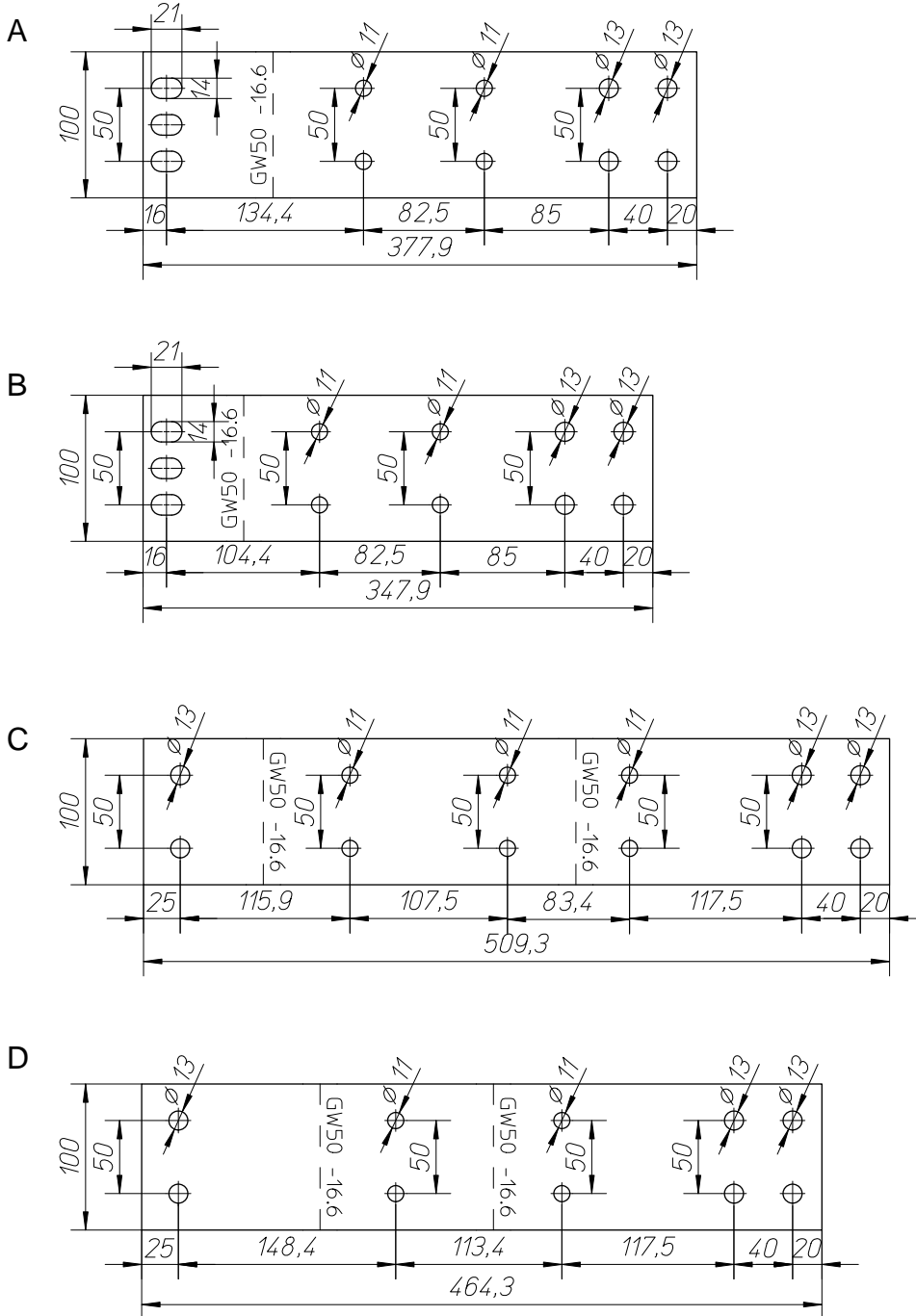

Einspeise-, Abgangsfeld IZM32 Festeinbau 3200A ungl. S. incoming-, outgoing unit IZM32 fix 3200A OPPO

Stückliste Eingangsschienenverbindung / parts list incoming connection

Pos. no.	Menge quantity		Benennung name	Beschreibung specification	Bild picture
	3P	4P			
1	6 Stk/pcs	8 Stk/pcs	Sechskantschraube Hexagon head cap screw	DIN EN 24014 M10 x 40 – 8.8	
2	12 Stk/pcs	16 Stk/pcs	Sechskantschraube Hexagon head cap screw	DIN EN 24014 M10 x 50 – 8.8	
3	6 Stk/pcs	8 Stk/pcs	Sechskantschraube Hexagon head cap screw	DIN EN 24014 M10 x 60 – 8.8	
4	6 Stk/pcs	8 Stk/pcs	Sechskantschraube Hexagon head cap screw	DIN EN 24014 M10 x 80 – 8.8	
5	60 Stk/pcs	80 Stk/pcs	Spannscheibe Conical spring washer for bolted connections	DIN 6796-10-FST	
6	30 Stk/pcs	40 Stk/pcs	Sechskantmutter Hexagon nut	DIN EN 24032 M10 – 8.8	
7	12 Stk/pcs	16 Stk/pcs	Sechskantschraube Hexagon head cap screw	DIN EN 24014 M12 x 60 – 8.8	
8	24 Stk/pcs	32 Stk/pcs	Spannscheibe Conical spring washer for bolted connections	DIN 6796-12-FST	
9	12 Stk/pcs	16 Stk/pcs	Sechskantmutter Hexagon nut	DIN EN 24032 M12 – 8.8	
10	4 Stk/pcs	4 Stk/pcs	Sechskantschraube Hexagon head cap screw	DIN EN 24014 M8 x 45 – 8.8	
11	8 Stk/pcs	8 Stk/pcs	Spannscheibe Conical spring washer for bolted connections	DIN 6796-8-FST	
12	4 Stk/pcs	4 Stk/pcs	Sechskantmutter Hexagon nut	DIN EN 24032 M8 – 8.8	
13	3 Stk/pcs	3 Stk/pcs	Stabilisator 50x10x481 / 354(3P) stabilizer 50x10x481 / 354(3P)	HM2471 DIN7735	
14	2 Stk/pcs	2 Stk/pcs	Stabilisator 30x30x690 /490(3P) Stabilizer 30x30x690 /490(3P)	HM2471 DIN7735	
15	2 Stk/pcs	2 Stk/pcs	Befestigungswinkel Fixing Bracket	XNBW-G BI 3,0 DIN59232 ST 02 Z275	
16	2 Stk/pcs	2 Stk/pcs	Befestigungswinkel Fixing Bracket Befestigungswinkel groß (Tiefe 800 / depth 800)	XNBW-E06 XNBW-E08 (Tiefe 800 / depth 800) BI 3,0 DIN59232 ST 02 Z275	

Anzugsdrehmomente / stud torque

Gewindegröße Screw Size	Fertigung Mounting	Prüfung Test
M8	20 Nm	17 Nm
M10	40 Nm	37 Nm
M12	70 Nm	67 Nm

Einspeise-, Abgangsfeld IZM32 Festeinbau 3200A ungl. S. incoming-, outgoing unit IZM32 fix 3200A OPPO

Abgangsschienenverbindung / outgoing connection

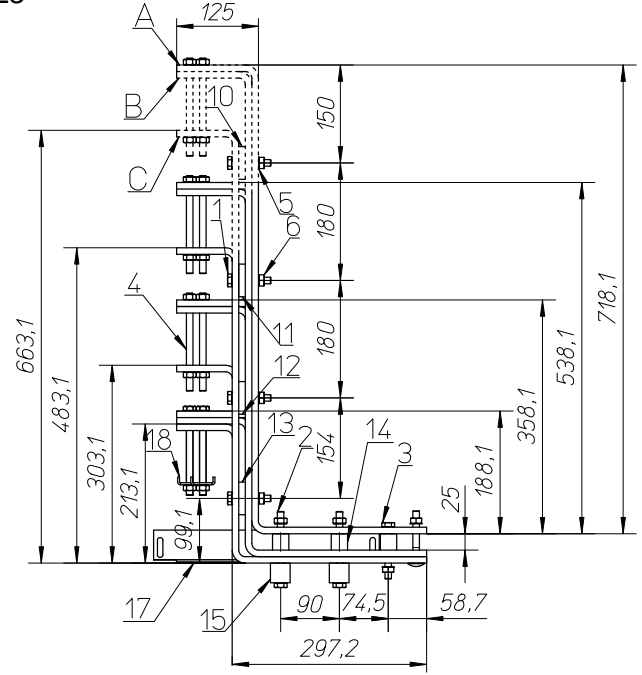
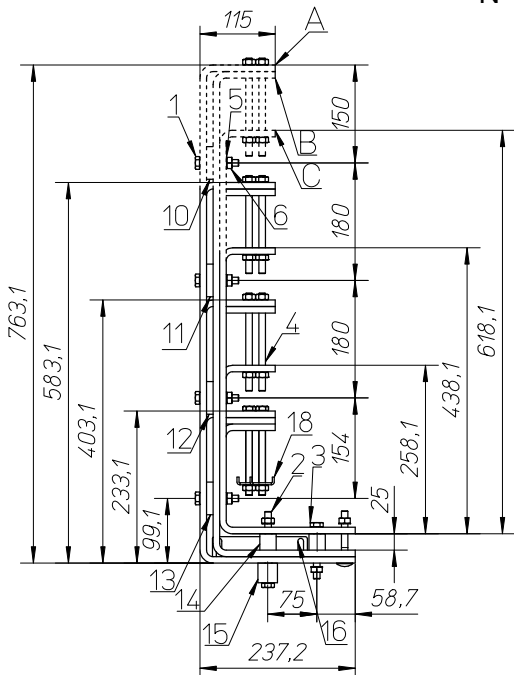
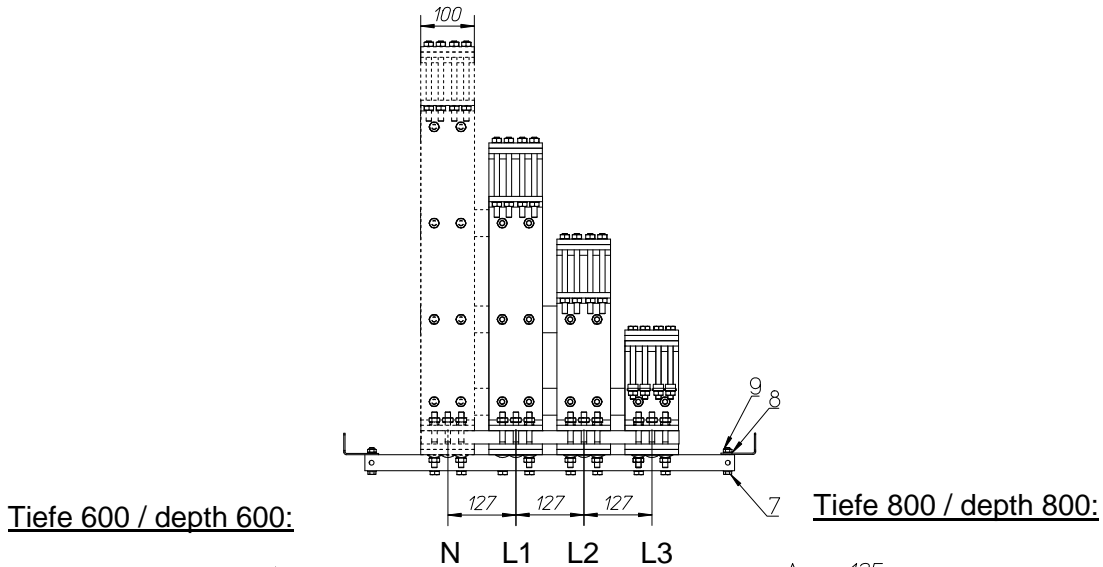

Kupfer / copper 100mm x 10mm Gestreckte Längen* / flat length*								
Schiene busbar	Gestreckte Länge N flat length N Tiefe / depth		Gestreckte Länge L1 flat length L1 Tiefe / depth		Gestreckte Länge L2 flat length L2 Tiefe / depth		Gestreckte Länge L3 flat length L3 Tiefe / depth	
	600	800	600	800	600	800	600	800
A	1082,1mm	1077,1mm	902,1mm	897,1mm	722,1mm	717,1mm	552,1mm	547,1mm
B	1022,1mm	1102,1mm	842,1mm	922,1mm	662,1mm	742,1mm	492,1mm	572,1mm
C	877,1mm	1022,1mm	697,1mm	842,1mm	517,1mm	662,1mm	427,1mm	572,1mm

*Radius R10

Biegever Kürzung / correction factor: +3,4mm

Einspeise-, Abgangsfeld IZM32 Festeinbau 3200A ungl. S. incoming-, outgoing unit IZM32 fix 3200A OPPO

Abgangsschienenverbindung / outgoing connection

Pos. / No. 10
Stabilisator
stabilizer
50x10x100

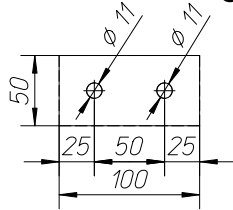

Pos. / No. 11
Stabilisator
stabilizer
50x10x227

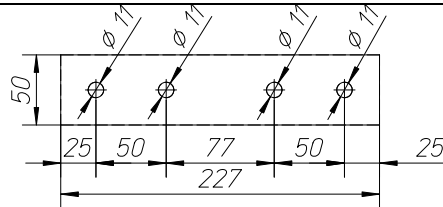

Pos. / No. 12
Stabilisator
stabilizer
50x10x354

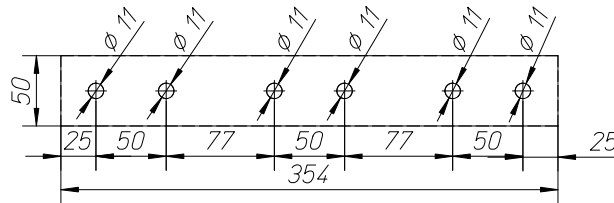

Pos. / No. 13
Stabilisator
stabilizer
50x10x481

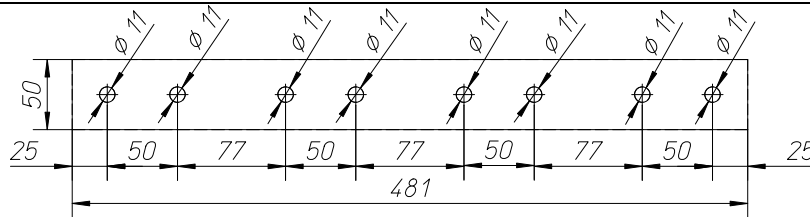

Pos. / No. 14
Stabilisator
stabilizer
25x25x481 / 354(3P)

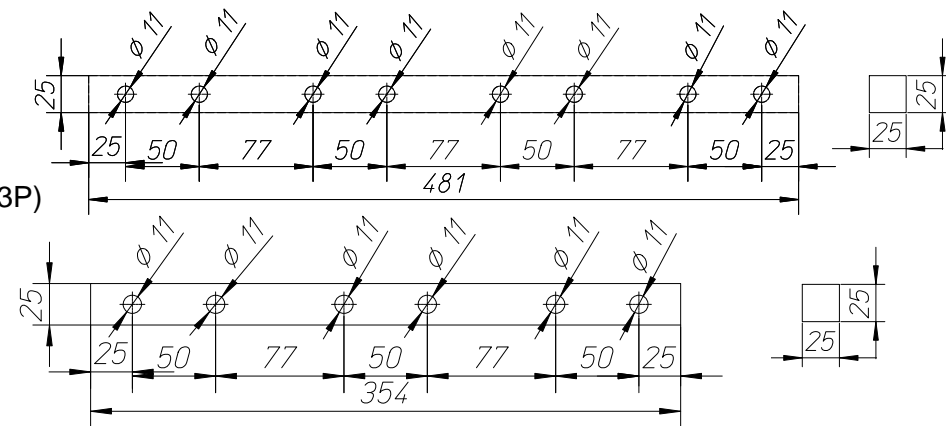

Pos. / No. 15
Stabilisator
stabilizer
30x30x690 / 490(3P)

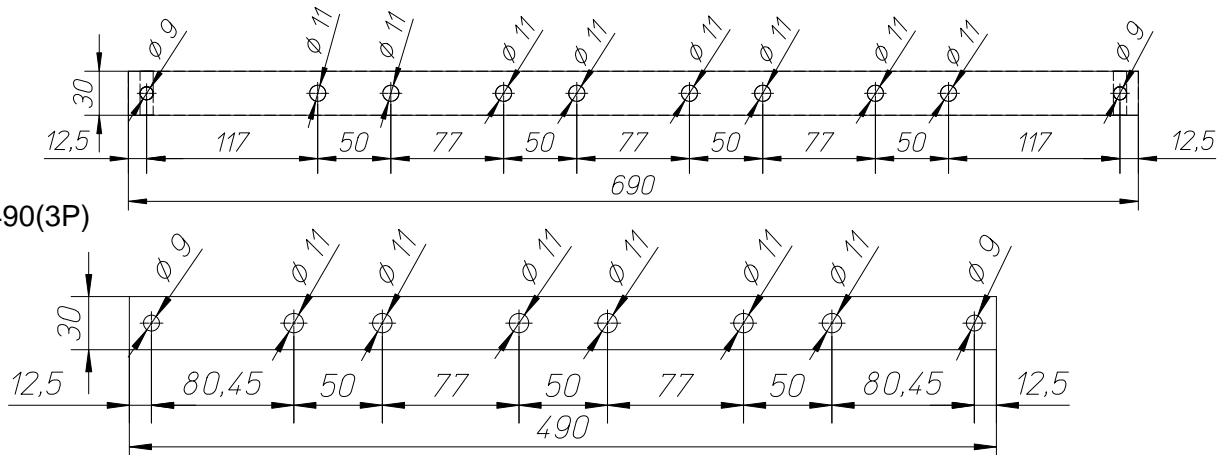

Einspeise-, Abgangsfeld IZM32 Festeinbau 3200A ungl. S. incoming-, outgoing unit IZM32 fix 3200A OPPO

Gestreckte Längen Tiefe 600 / flat length depth 600

A:
N

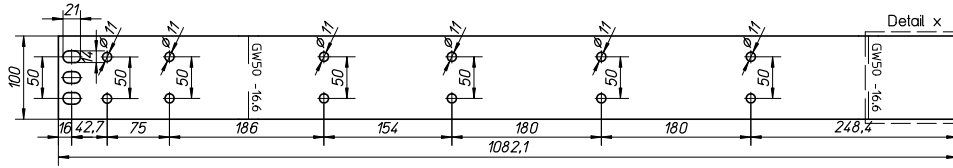

L1

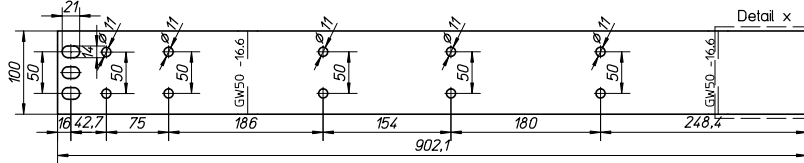

L2

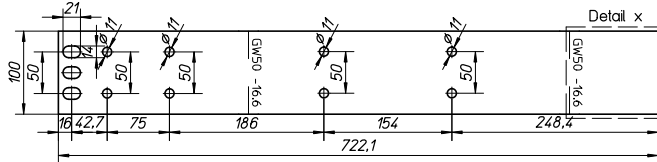

L3

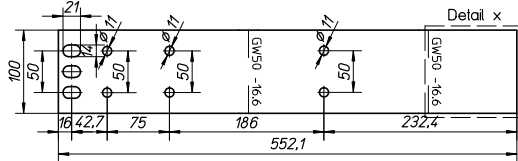

B:
N

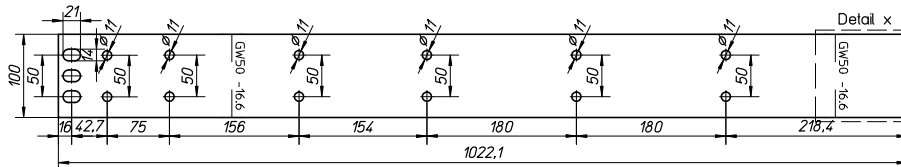

L1

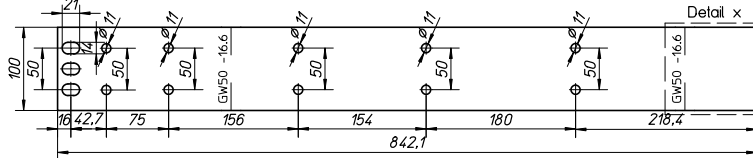

L2

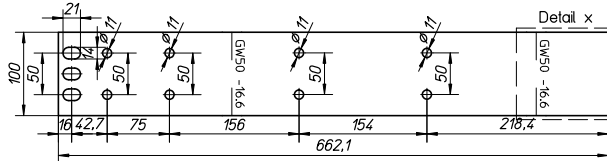

L3

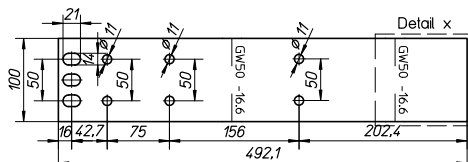

Einspeise-, Abgangsfeld IZM32 Festeinbau 3200A ungl. S. incoming-, outgoing unit IZM32 fix 3200A OPPO

Gestreckte Längen Tiefe 600 / flat length depth 600

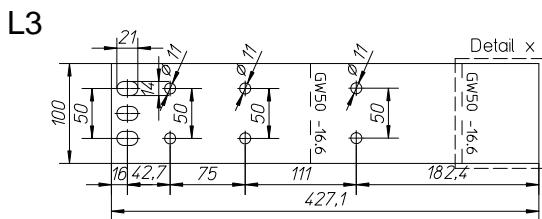
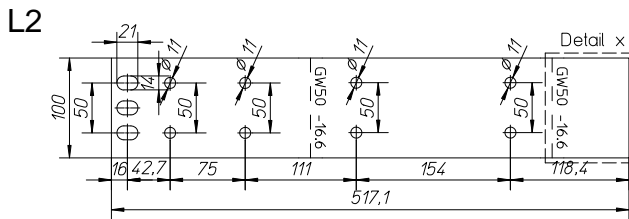
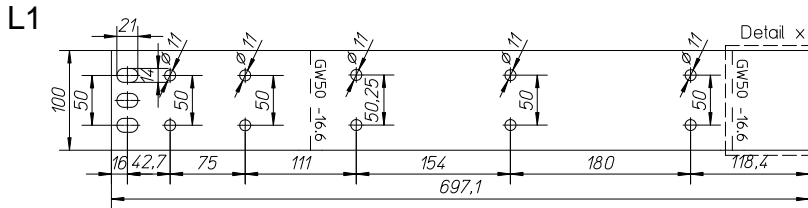
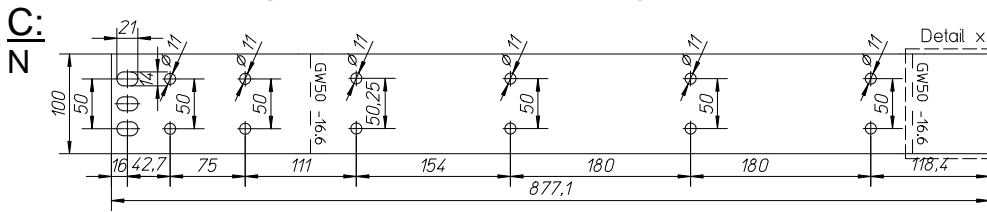

Detail
HSS mit 3 Cu-Schienen
Main busbar with 3 Cu-bars

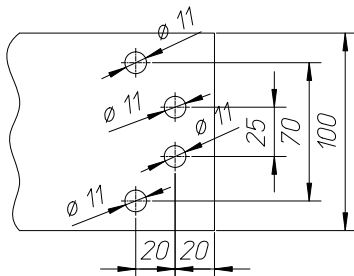

Einspeise-, Abgangsfeld IZM32 Festeinbau 3200A ungl. S. incoming-, outgoing unit IZM32 fix 3200A OPPO

Gestreckte Längen Tiefe 800 / flat length depth 800

A:
N

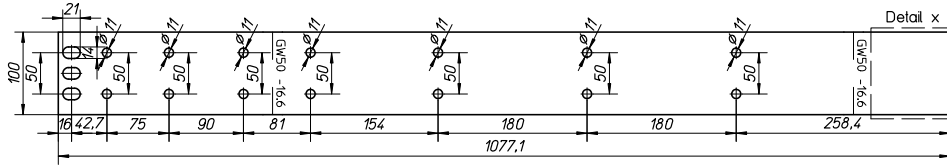

L1

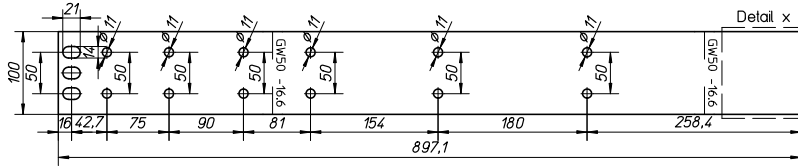

L2

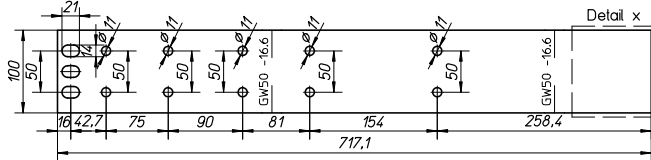

L3

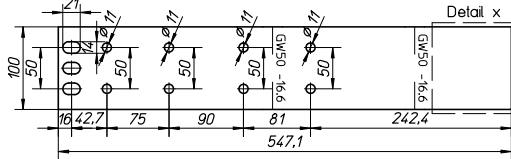

B:
N

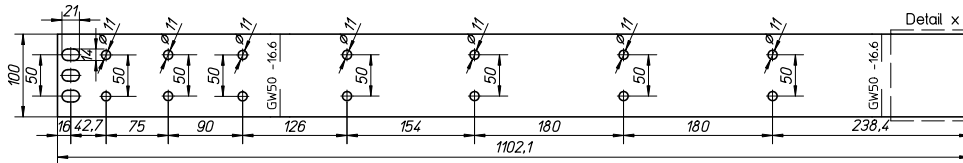

L1

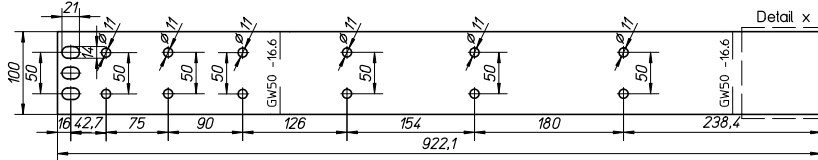

L2

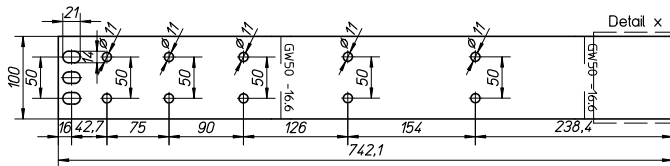

L3

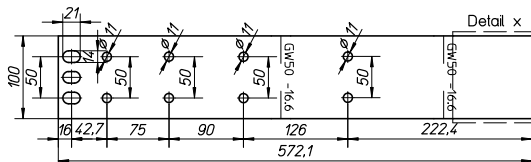

Einspeise-, Abgangsfeld IZM32 Festeinbau 3200A ungl. S. incoming-, outgoing unit IZM32 fix 3200A OPPO

Gestreckte Längen Tiefe 800 / flat length depth 800

C:
N

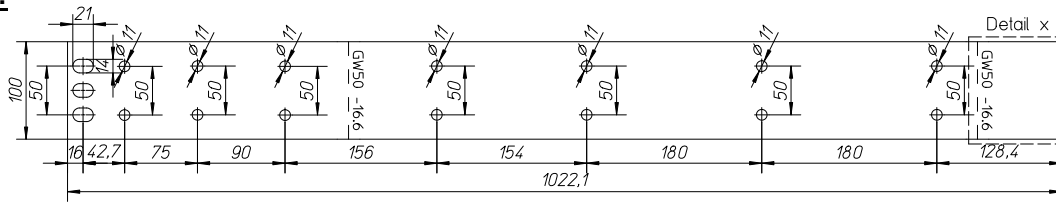

L1

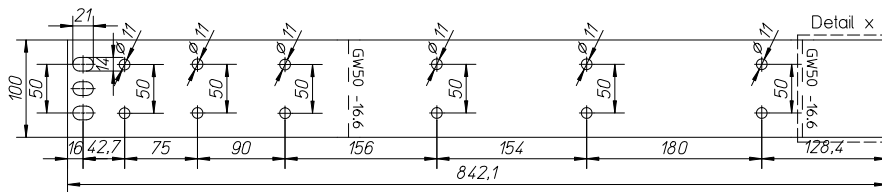

L2

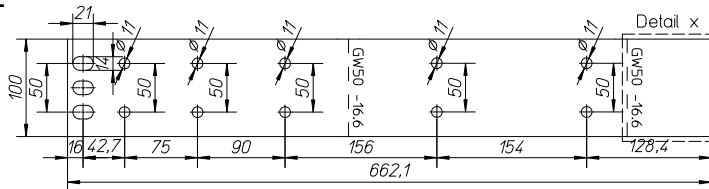

L3

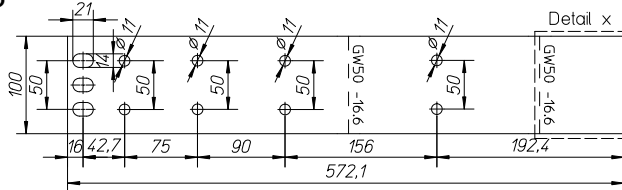

Detail
HSS mit 3 Cu-Schienen
Main busbar with 3 Cu-bars

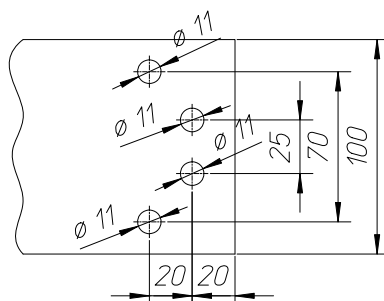

Einspeise-, Abgangsfeld IZM32 Festeinbau 3200A ungl. S. incoming-, outgoing unit IZM32 fix 3200A OPPO

Stückliste Abgangsschienenverbindung / parts list outgoing connection

Pos. no.	Menge quantity Tiefe / depth				Benennung name	Beschreibung specification	Bild picture
	600		800				
	3P	4P	3P	4P			
1	12 Stk/pcs	20 Stk/pcs	12 Stk/pcs	20 Stk/pcs	Sechskantschraube Hexagon head cap screw	DIN EN 24014 M10 x 60 – 8.8	
2	6 Stk/pcs	8 Stk/pcs	12 Stk/pcs	16 Stk/pcs	Sechskantschraube Hexagon head cap screw	DIN EN 24014 M10 x 110 – 8.8	
3	6 Stk/pcs	8 Stk/pcs	6 Stk/pcs	8 Stk/pcs	Sechskantschraube Hexagon head cap screw	DIN EN 24014 M10 x 80 – 8.8	
4	12 Stk/pcs	16 Stk/pcs	12 Stk/pcs	16 Stk/pcs	Stiftschraube Stud screw	DIN 939 M10x140 – 8.8	
5	96 Stk/pcs	136 Stk/pcs	108 Stk/pcs	152 Stk/pcs	Spannscheibe Conical spring washer for bolted connections	DIN 6796-10-FST	
6	48 Stk/pcs	68 Stk/pcs	54 Stk/pcs	76 Stk/pcs	Sechskantmutter Hexagon nut	DIN EN 24032 M10 – 8.8	
7	2 Stk/pcs	2 Stk/pcs	4 Stk/pcs	4 Stk/pcs	Sechskantschraube Hexagon head cap screw	DIN EN 24014 M8 x 45 – 8.8	
8	4 Stk/pcs	4 Stk/pcs	8 Stk/pcs	8 Stk/pcs	Spannscheibe Conical spring washer for bolted connections	DIN 6796-8-FST	
9	2 Stk/pcs	2 Stk/pcs	4 Stk/pcs	4 Stk/pcs	Sechskantmutter Hexagon nut	DIN EN 24032 M8 – 8.8	
10	1 Stk/pcs	1 Stk/pcs	1 Stk/pcs	1 Stk/pcs	Stabilisator 50x10x100 stabilizer 50x10x100	HM2471 DIN7735	
11	1 Stk/pcs	-	1 Stk/pcs	-	Stabilisator 50x10x227 stabilizer 50x10x227	HM2471 DIN7735	
12	1 Stk/pcs	-	1 Stk/pcs	-	Stabilisator 50x10x354 stabilizer 50x10x354	HM2471 DIN7735	
13	-	3 Stk/pcs	-	3 Stk/pcs	Stabilisator 50x10x481 stabilizer 50x10x481	HM2471 DIN7735	
14	2 Stk/pcs	2 Stk/pcs	3 Stk/pcs	3 Stk/pcs	Stabilisator 25x25x481 / 354 (3P) Stabilizer 25x25x481 / 354 (3P)	HM2471 DIN7735	
15	1 Stk/pcs	1 Stk/pcs	2 Stk/pcs	2 Stk/pcs	Stabilisator 30x30x690 / 490(3P) Stabilizer 30x30x690 / 490(3P)	HM2471 DIN7735	
16	2 Stk/pcs	2 Stk/pcs	-	-	Befestigungswinkel Fixing Bracket	XNBW-E06 BI 3,0 DIN59232 ST 02 Z275	
17	-	-	2 Stk/pcs	2 Stk/pcs	Befestigungswinkel groß Fixing Bracket	XNBW-E08 BI 3,0 DIN59232 ST 02 Z275	
18	4 Stk/pcs	4 Stk/pcs	4 Stk/pcs	4 Stk/pcs	Cu-Bügel Copper Clamps	XNCB EN 13601-Cu- ETP-R250	

Anzugsdrehmomente / stud torque

Gewindegröße Screw Size	Fertigung Mounting	Prüfung Test
M8	20 Nm	17 Nm
M10	40 Nm	37 Nm