

Einspeise-, Abgangsfeld IZM20 Festeinbau 2000A incoming-, outgoing unit IZM20 fix 2000A

Aufbau Feld / installation field

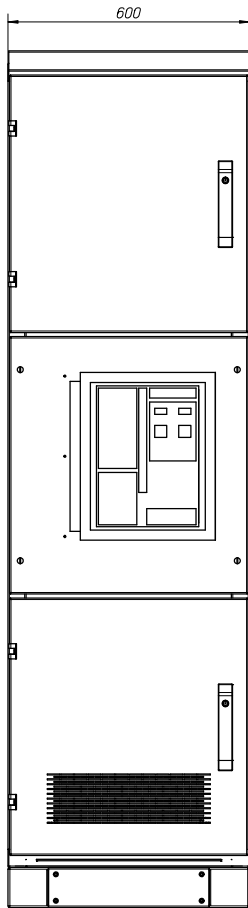

3-polig/ 3-pole

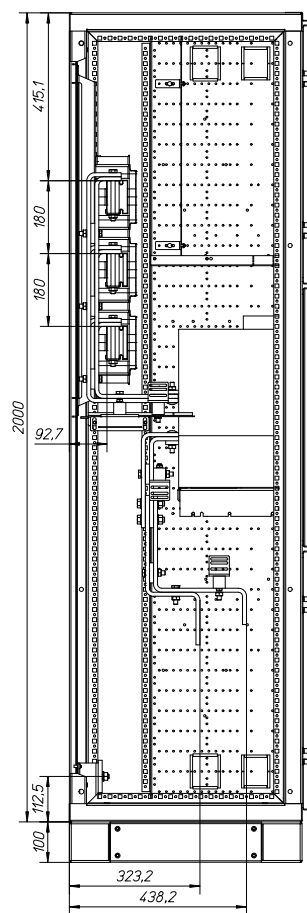

4-polig/ 4-pole

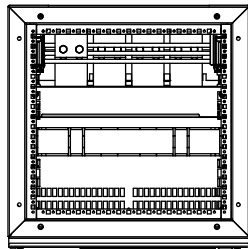
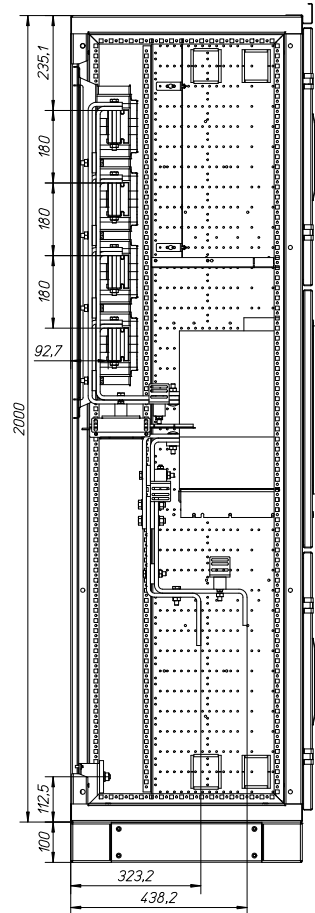

xEnergy Feld / field 2000x600x600/800

Einbausatz / mounting kit: IZM20

IZM20

Bemessungsstrom / Current Rating (I): 2000A

Material der Cu-Schienen / busbar material: EN 13601-Cu-ETP-R250
(ersetzt / replaced: DIN 40500 / 46433 E-Cu 57, F25)

Hinweis / note:

Kupferaufbau kann horizontal gespiegelt werden!
Copper construction can be mounted upside down!

Einspeise-, Abgangsfeld IZM20 Festeinbau 2000A incoming-, outgoing unit IZM20 fix 2000A

Eingangsschienenverbindung / incoming connection

3-polig / 3-pole

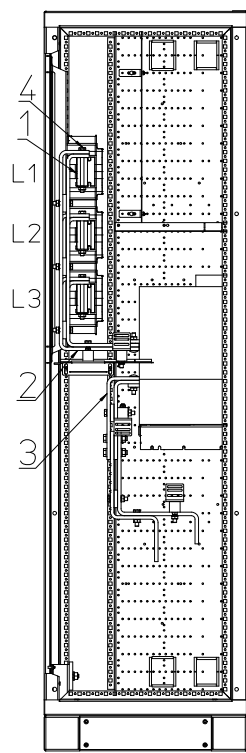
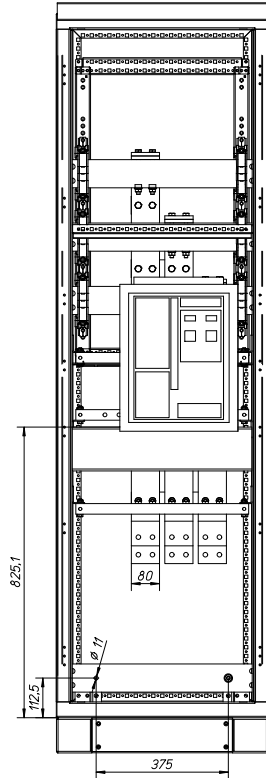

4-polig / 4-pole

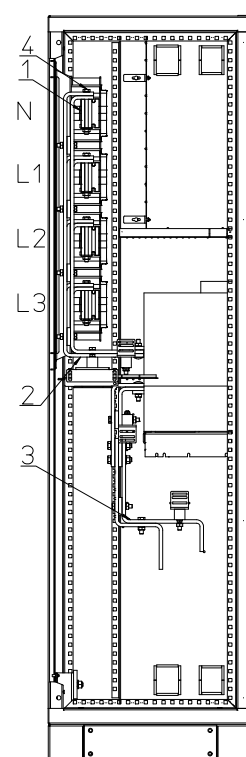
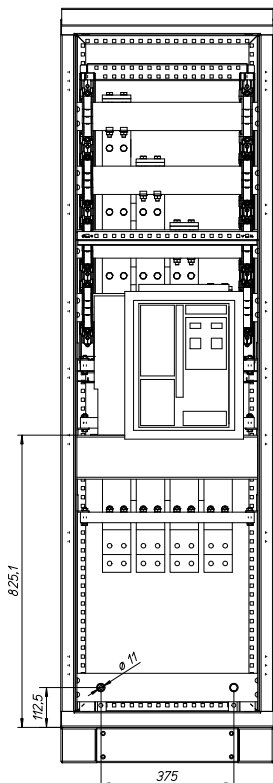

Einspeise-, Abgangsfeld IZM20 Festeinbau 2000A incoming-, outgoing unit IZM20 fix 2000A

Anschluss Schalter - Gesamtansicht / switch connection - overview

Pos. no.	Benennung name	Beschreibung specification	Montagematerial/Zubehör Installation material/ comonents
1	Hauptsammelschiene main busbar		
2	Abgangssammelschiene outgoing busbar	2x80x10 mm	Blatt 8-14 Page 8-14
3	Eingangssammelschiene incoming busbar	2x80x10 mm	Blatt 4-7 Page 4-7
4	Sammelschienenverbindung busbar connection		Blatt 8-14 Page 8-14

3-polig / 3-pole

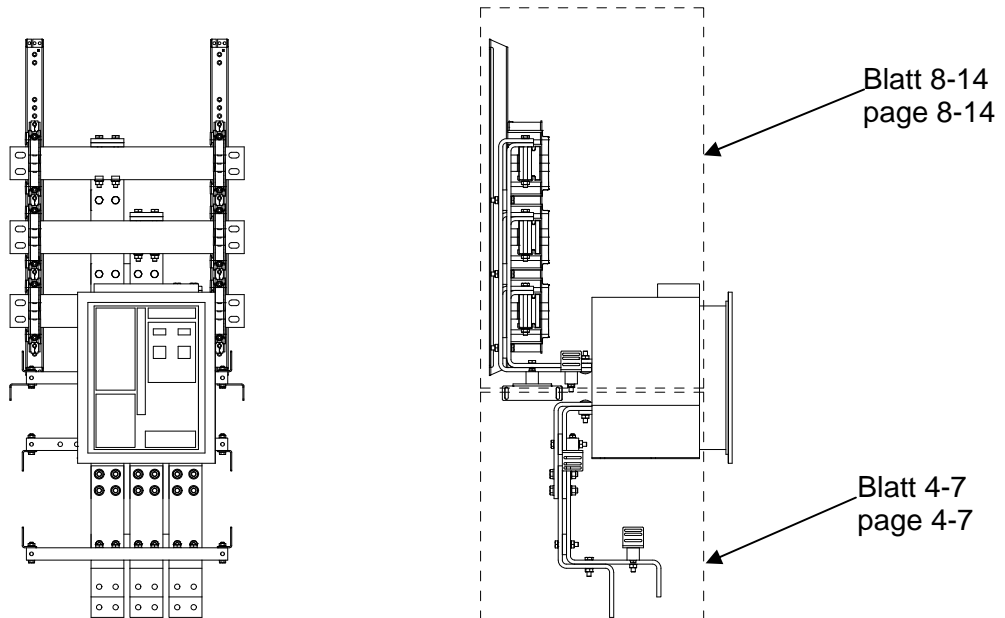

4-polig / 4-pole

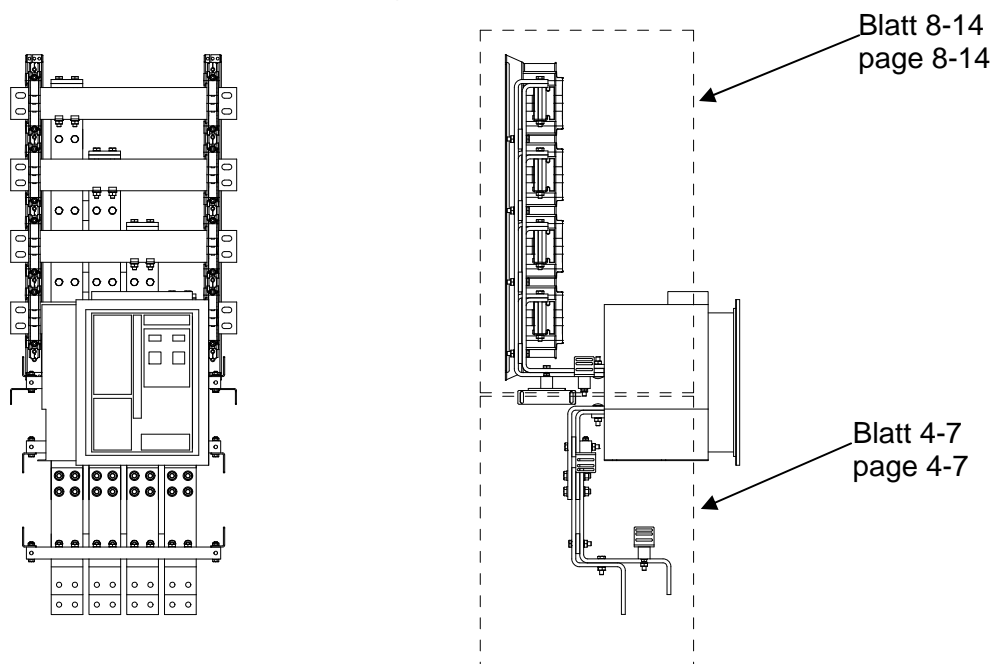

Einspeise-, Abgangsfeld IZM20 Festeinbau 2000A incoming-, outgoing unit IZM20 fix 2000A

Eingangsschienenverbindung / incoming connection

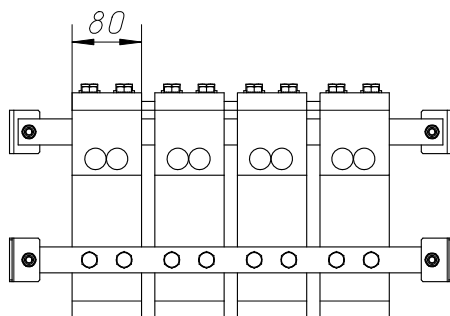
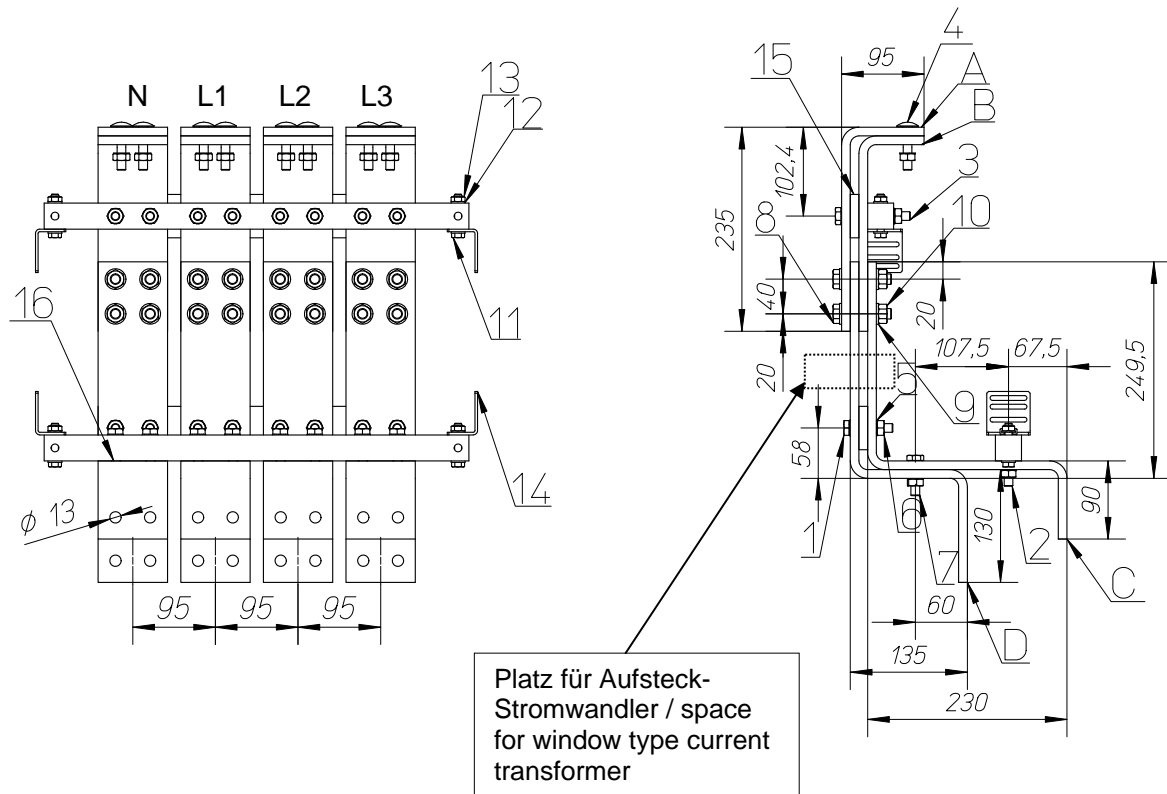

Kupfer / copper 80mm x 10mm
Gestreckte Längen* / flat length*

Schiene busbar	Gestreckte Länge N flat length N	Gestreckte Länge L1 flat length L1	Gestreckte Länge L2 flat length L2	Gestreckte Länge L3 flat length L3
A	313,4mm	313,4mm	313,4mm	313,4mm
B	283,4mm	283,4mm	283,4mm	283,4mm
C	526,3mm	526,3mm	526,3mm	526,3mm
D	481,3mm	481,3mm	481,3mm	481,3mm

*Radius R10

Biegeverkürzung / correction factor: +3,4mm

Einspeise-, Abgangsfeld IZM20 Festeinbau 2000A incoming-, outgoing unit IZM20 fix 2000A

Eingangsschienenverbindung / incoming connection

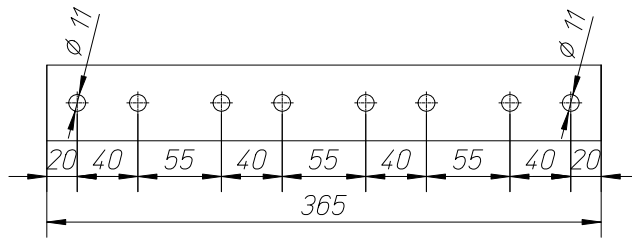

Pos. / No. 15
Stabilisator
stabilizer
50x10x365 / 270(3P)

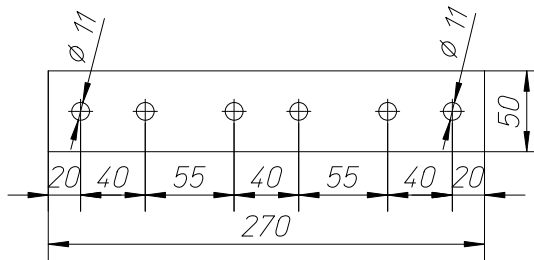

Pos. / No. 16
Stabilisator
stabilizer
30x30x490

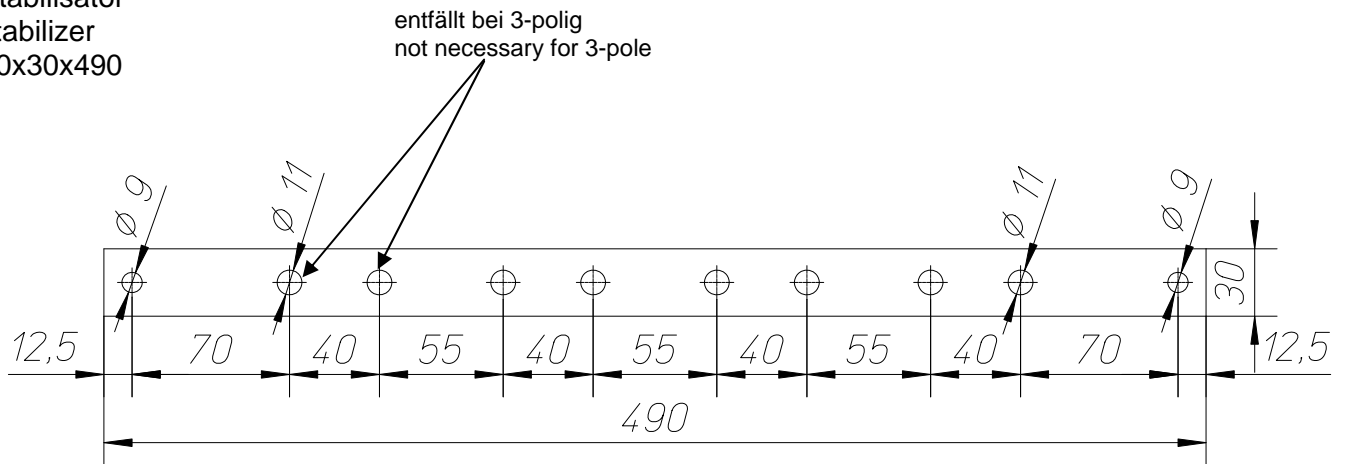

Einspeise-, Abgangsfeld IZM20 Festeinbau 2000A incoming-, outgoing unit IZM20 fix 2000A

Gestreckte Längen / flat length

A

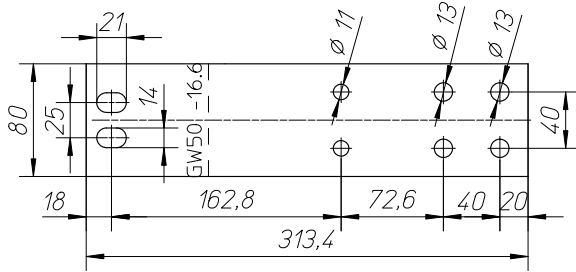

B

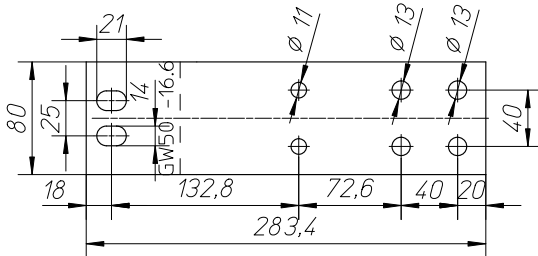

C

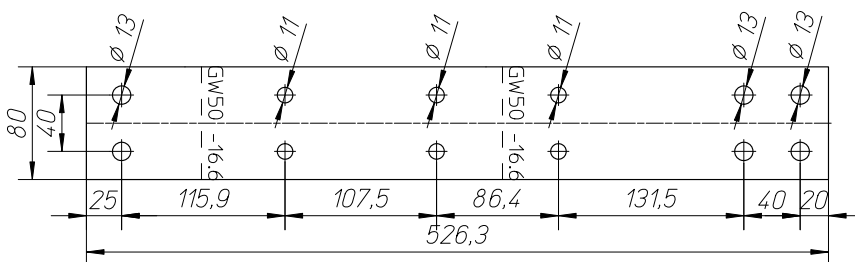

D

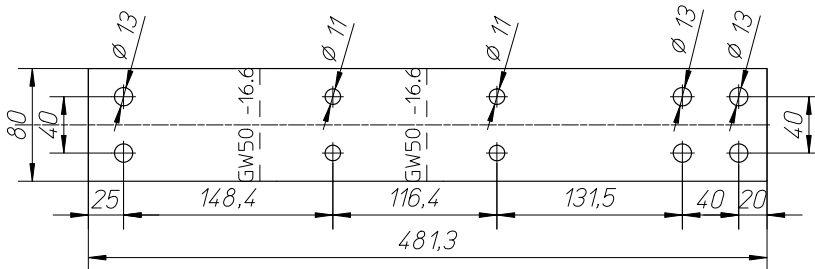

Einspeise-, Abgangsfeld IZM20 Festeinbau 2000A incoming-, outgoing unit IZM20 fix 2000A

Stückliste Eingangsschienenverbindung / parts list incoming connection

Pos. no.	Menge quantity		Benennung name	Beschreibung specification	Bild picture
	3P	4P			
1	6 Stk/pcs	8 Stk/pcs	Sechskantschraube Hexagon head cap screw	DIN EN 24014 M10 x 50 – 8.8	
2	6 Stk/pcs	8 Stk/pcs	Sechskantschraube Hexagon head cap screw	DIN EN 24014 M10 x 60 – 8.8	
3	6 Stk/pcs	8 Stk/pcs	Sechskantschraube Hexagon head cap screw	DIN EN 24014 M10 x 80 – 8.8	
4	6 Stk/pcs	8 Stk/pcs	Flachrundschrube mit Vierkantansatz Saucer-head screw with square neck	DIN 603 M10 x 50 – 8.8	
5	54 Stk/pcs	70 Stk/pcs	Spannscheibe Conical spring washer for bolted connections	DIN 6796-10-FST	
6	30 Stk/pcs	40 Stk/pcs	Sechskantmutter Hexagon nut	DIN EN 24032 M10 – 8.8	
7	6 Stk/pcs	8 Stk/pcs	Sechskantschraube Hexagon head cap screw	DIN EN 24014 M10 x 40 – 8.8	
8	12 Stk/pcs	16 Stk/pcs	Sechskantschraube Hexagon head cap screw	DIN EN 24014 M12 x 60 – 8.8	
9	24 Stk/pcs	32 Stk/pcs	Spannscheibe Conical spring washer for bolted connections	DIN 6796-12-FST	
10	12 Stk/pcs	16 Stk/pcs	Sechskantmutter Hexagon nut	DIN EN 24032 M12 – 8.8	
11	4 Stk/pcs	4 Stk/pcs	Sechskantschraube Hexagon head cap screw	DIN EN 24014 M8 x 45 – 8.8	
12	8 Stk/pcs	8 Stk/pcs	Spannscheibe Conical spring washer for bolted connections	DIN 6796-8-FST	
13	4 Stk/pcs	4 Stk/pcs	Sechskantmutter Hexagon nut	DIN EN 24032 M8 – 8.8	
14	4 Stk/pcs	4 Stk/pcs	Befestigungswinkel Fixing Bracket	XNBW-G BI 3,0 DIN59232 ST 02 Z275	
15	2 Stk/pcs	2 Stk/pcs	Stabilisator 50x10x365 / 270(3P) stabilizer 50x10x365 / 270(3P)	HM2471 DIN7735	
16	2 Stk/pcs	2 Stk/pcs	Stabilisator 30x30x490 Stabilizer 30x30x490	HM2471 DIN7735	

Anzugsdrehmomente / stud torque

Gewindegröße Screw Size	Fertigung Mounting	Prüfung Test
M8	20 Nm	17 Nm
M10	40 Nm	37 Nm
M12	70 Nm	67 Nm

Einspeise-, Abgangsfeld IZM20 Festeinbau 2000A incoming-, outgoing unit IZM20 fix 2000A

Abgangsschienenverbindung / outgoing connection

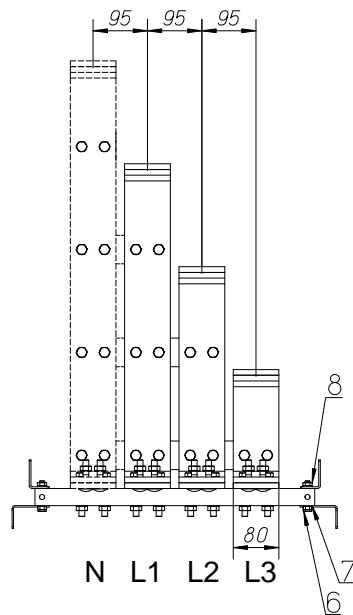
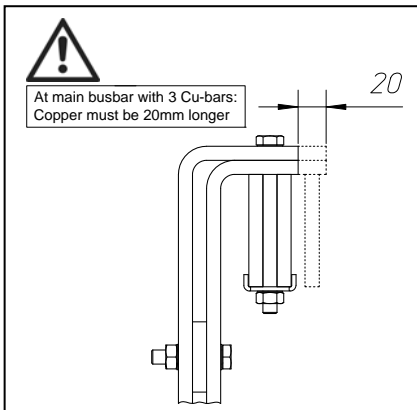

Tiefe 600 / depth 600:

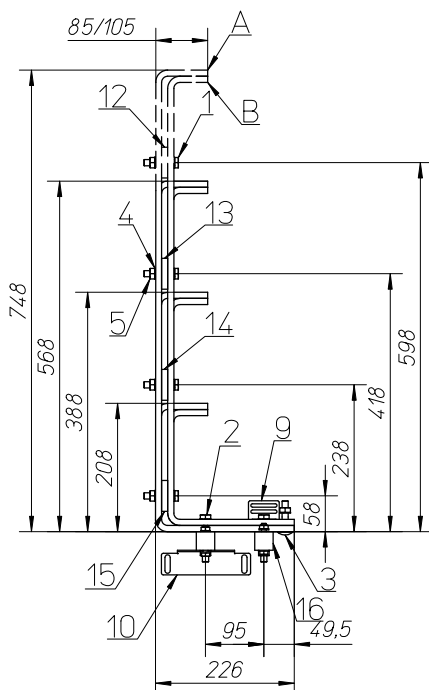

Tiefe 800 / depth 800:

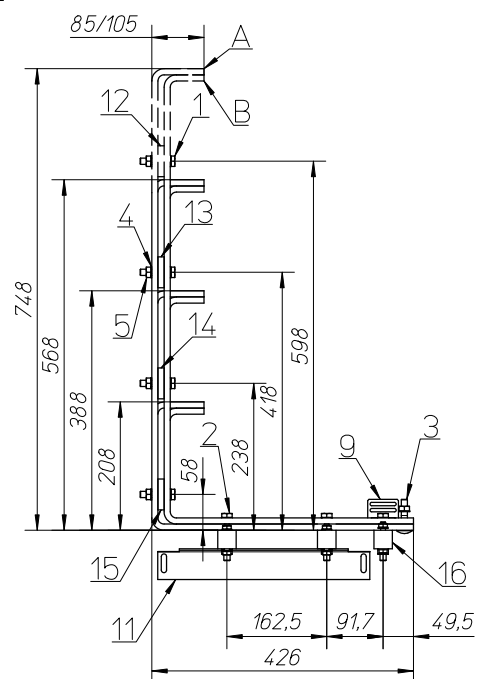

Kupfer / copper 80mm x 10mm Gestreckte Längen* / flat length*								
Schiene busbar	Gestreckte Länge N flat length N Tiefe / depth		Gestreckte Länge L1 flat length L1 Tiefe / depth		Gestreckte Länge L2 flat length L2 Tiefe / depth		Gestreckte Länge L3 flat length L3 Tiefe / depth	
	600	800	600	800	600	800	600	800
A	1025,8/ 1045,8mm	1225,8/ 1245,8mm	845,8/ 865,8mm	1045,8/ 1065,8mm	665,8/ 685,8mm	865,8/ 885,8mm	485,8/ 505,8mm	685,8/ 705,8mm
B	965,8/ 985,8mm	1165,8/ 1185,8mm	785,8/ 805,8mm	985,8/ 1005,8mm	605,8/ 625,8mm	805,8/ 825,8mm	425,8/ 445,8mm	625,8/ 645,8mm

*Radius R10

Biegeverkürzung / correction factor: +3,4mm

Einspeise-, Abgangsfeld IZM20 Festeinbau 2000A incoming-, outgoing unit IZM20 fix 2000A

Abgangsschienenverbindung / outgoing connection

Pos. / No. 12
Stabilisator
stabilizer
50x10x80

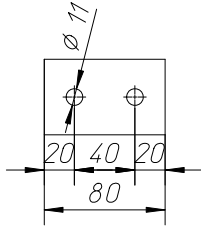

Pos. / No. 13
Stabilisator
stabilizer
50x10x175

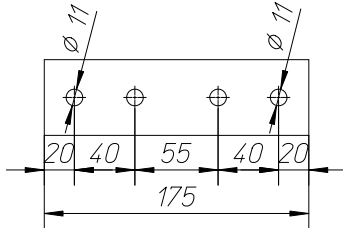

Pos. / No. 14
Stabilisator
stabilizer
50x10x270

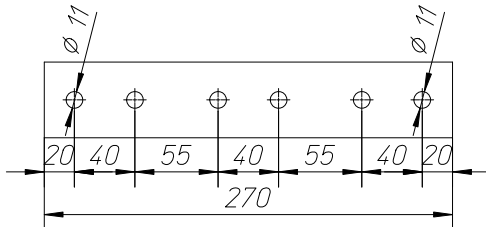

Pos. / No. 15
Stabilisator
stabilizer
50x10x365

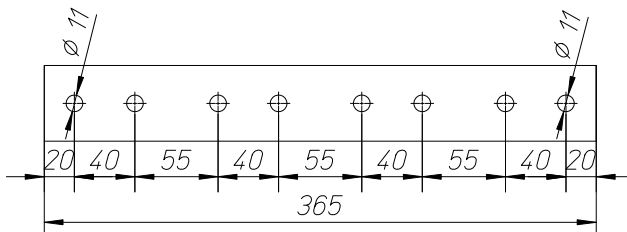

Pos. / No. 16
Stabilisator
stabilizer
30x30x490

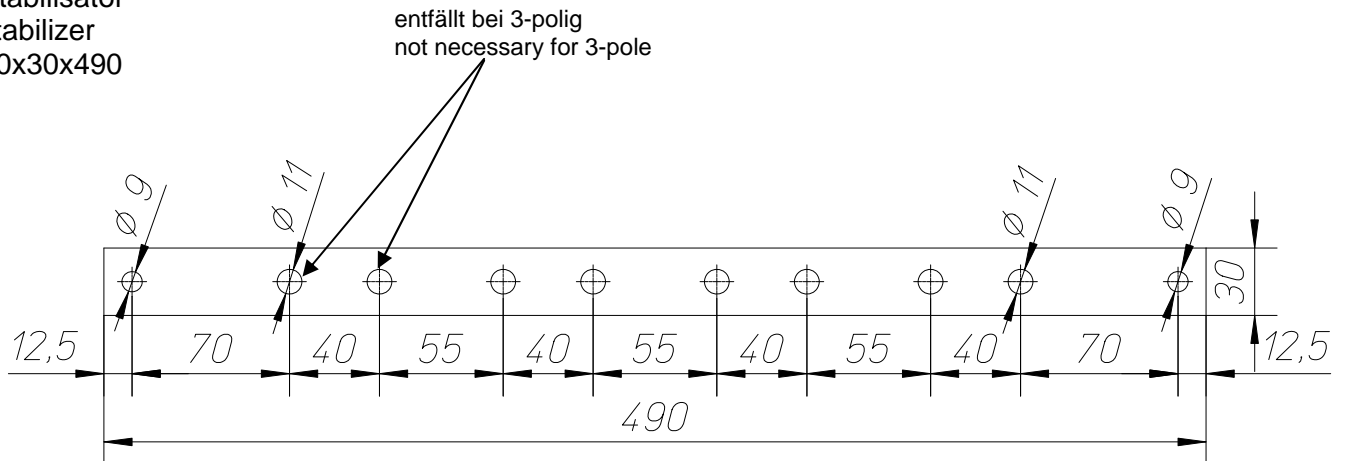

Einspeise-, Abgangsfeld IZM20 Festeinbau 2000A incoming-, outgoing unit IZM20 fix 2000A

Gestreckte Längen Tiefe 600 / flat length depth 600

N:

A

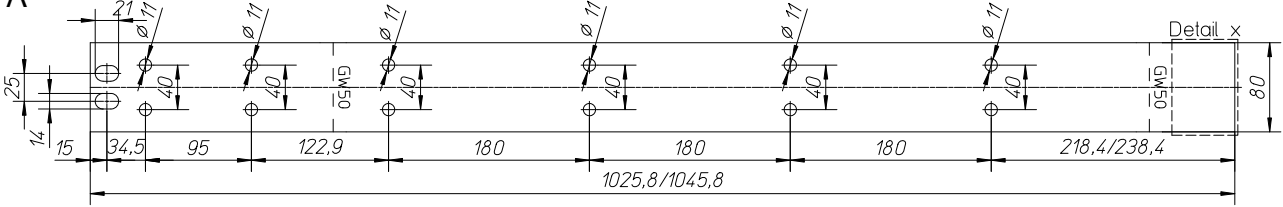

B

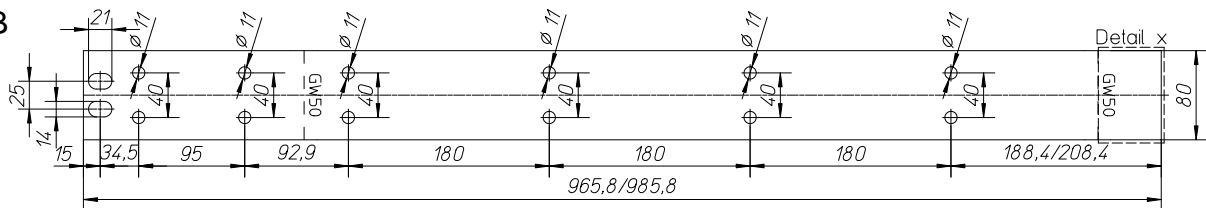

L1:

A

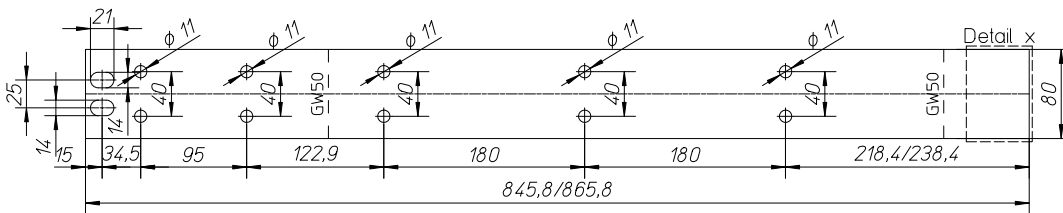

B

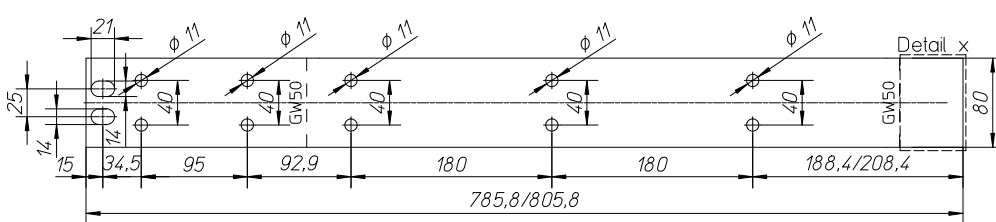

Detail x
HSS mit 2 Cu-Schienen
Main busbar with 2 Cu-bars

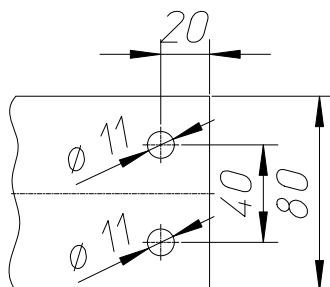

Detail x
HSS mit 3 Cu-Schienen
Main busbar with 3 Cu-bars

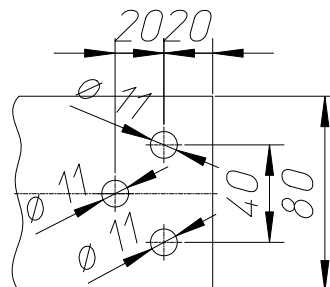

Einspeise-, Abgangsfeld IZM20 Festeinbau 2000A incoming-, outgoing unit IZM20 fix 2000A

L2:

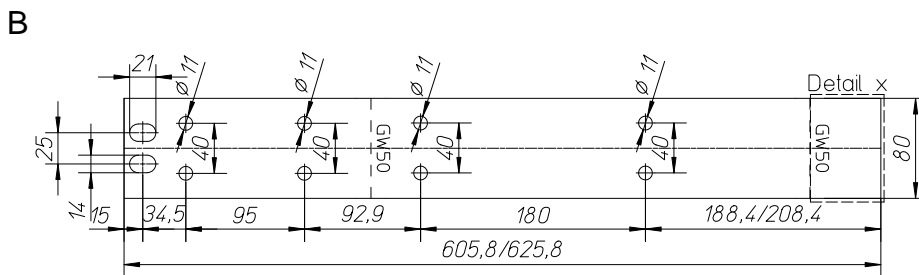
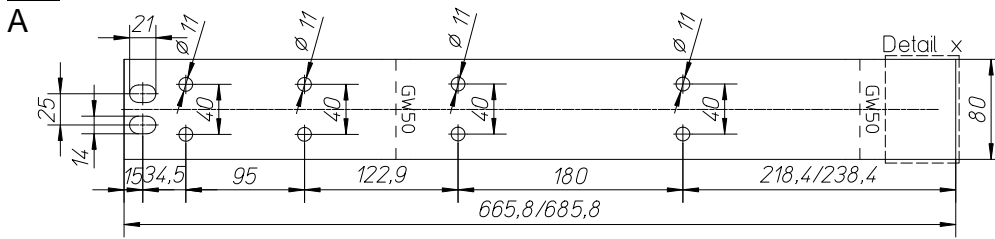

L3:

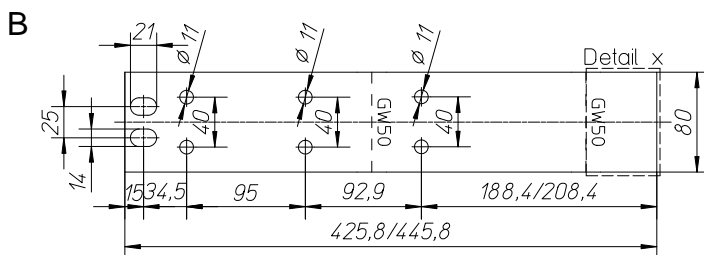
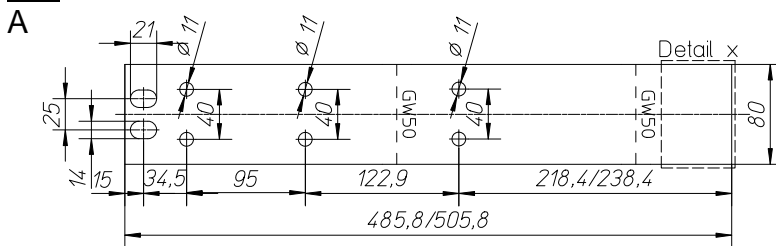

Detail x
HSS mit 2 Cu-Schienen
Main busbar with 2 Cu-bars

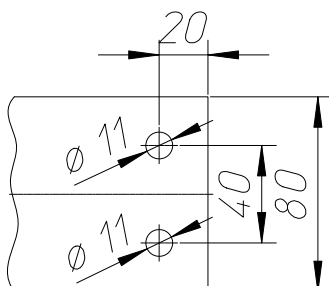

Detail x
HSS mit 3 Cu-Schienen
Main busbar with 3 Cu-bars

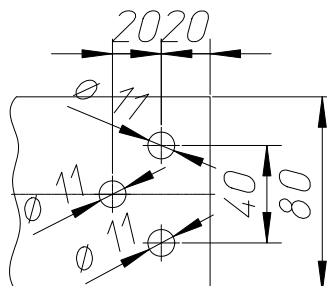

Einspeise-, Abgangsfeld IZM20 Festeinbau 2000A incoming-, outgoing unit IZM20 fix 2000A

Gestreckte Längen Tiefe 800 / flat length depth 800

N:

A

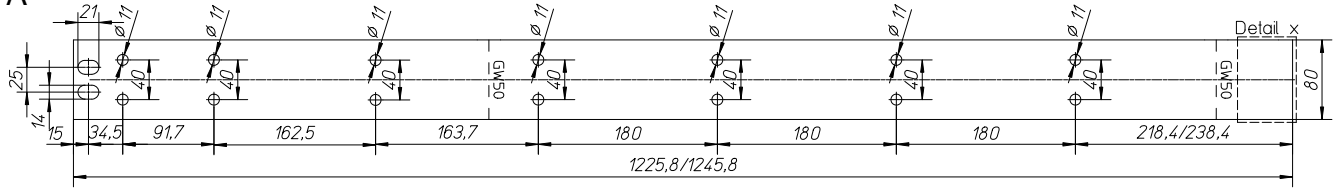

B

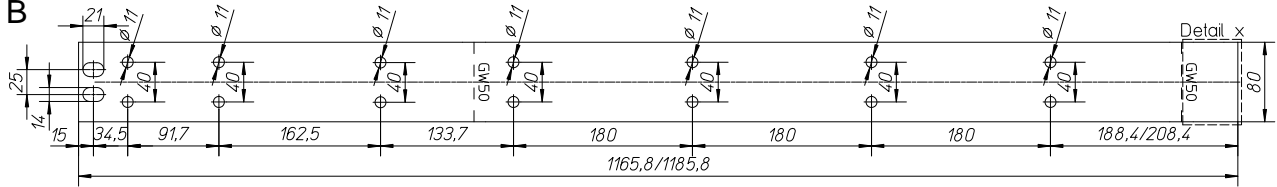

L1:

A

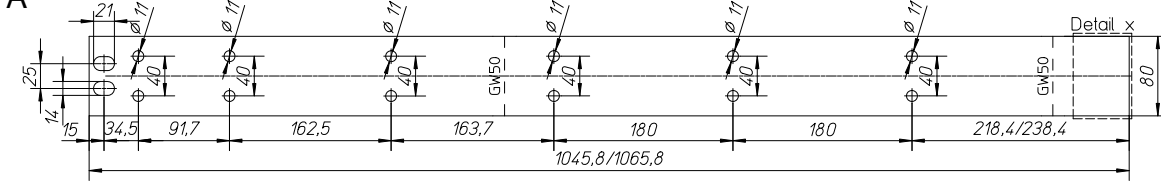

B

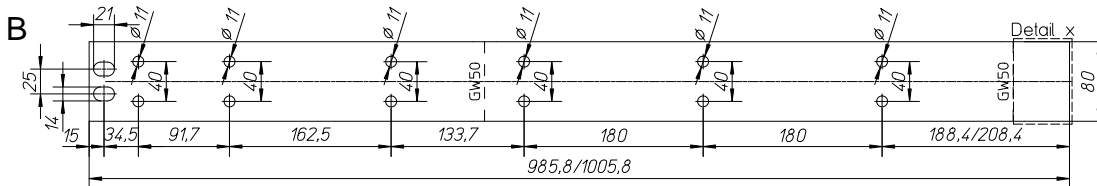

Detail x
HSS mit 2 Cu-Schienen
Main busbar with 2 Cu-bars

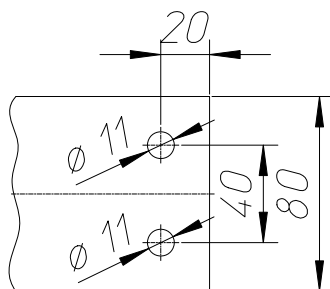

Detail x
HSS mit 3 Cu-Schienen
Main busbar with 3 Cu-bars

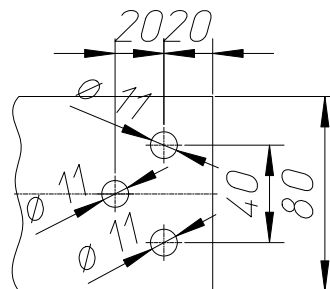

Einspeise-, Abgangsfeld IZM20 Festeinbau 2000A incoming-, outgoing unit IZM20 fix 2000A

L2:

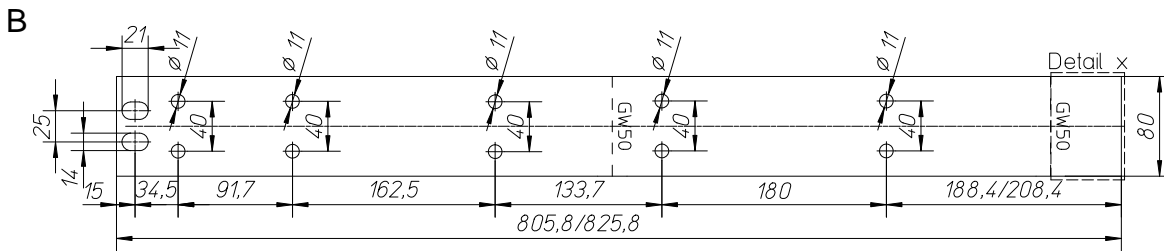
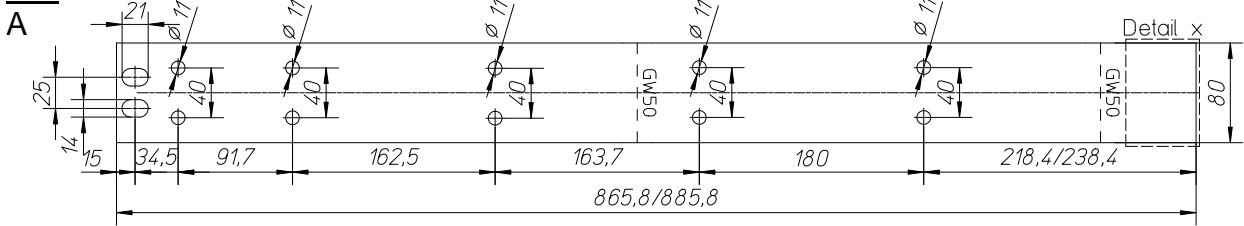

L3:

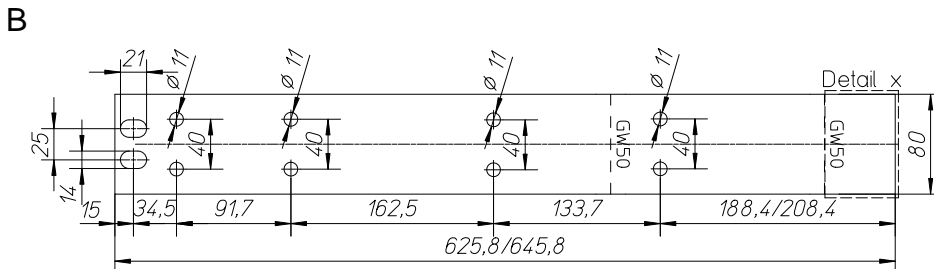
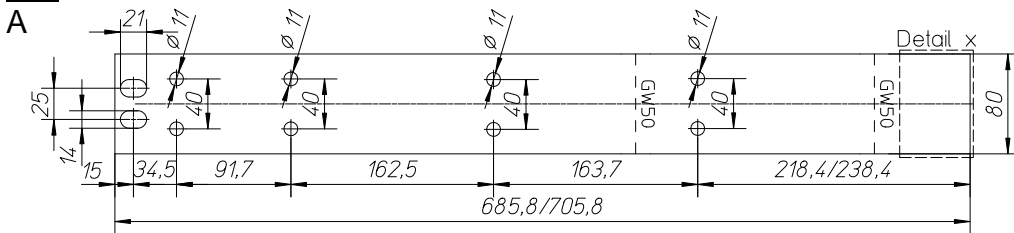

Detail x
HSS mit 2 Cu-Schienen
Main busbar with 2 Cu-bars

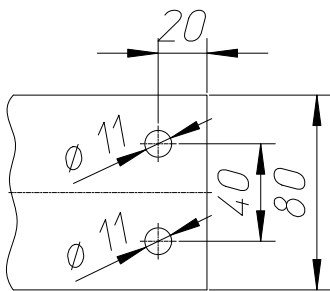

Detail x
HSS mit 3 Cu-Schienen
Main busbar with 3 Cu-bars

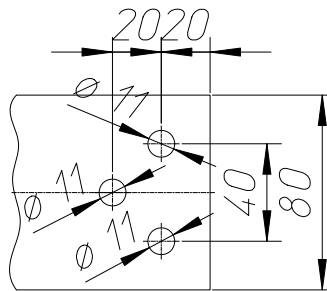

Einspeise-, Abgangsfeld IZM20 Festeinbau 2000A incoming-, outgoing unit IZM20 fix 2000A

Stückliste Abgangsschienenverbindung / parts list outgoing connection

Pos. no.	Menge quantity Tiefe / depth				Benennung name	Beschreibung specification	Bild picture
	600		800				
	3P	4P	3P	4P			
1	12 Stk/pcs	20 Stk/pcs	12 Stk/pcs	20 Stk/pcs	Sechskantschraube Hexagon head cap screw	DIN EN 24014 M10 x 50 – 8.8	
2	12 Stk/pcs	16 Stk/pcs	18 Stk/pcs	24 Stk/pcs	Sechskantschraube Hexagon head cap screw	DIN EN 24014 M10 x 70 – 8.8	
3	6 Stk/pcs	8 Stk/pcs	6 Stk/pcs	8 Stk/pcs	Flachrundschrube mit Vierkantansatz Saucer-head screw with square neck	DIN 603 M10 x 50 – 8.8	
4	54 Stk/pcs	80 Stk/pcs	66 Stk/pcs	96 Stk/pcs	Spannscheibe Conical spring washer for bolted connections	DIN 6796-10-FST	
5	30 Stk/pcs	44 Stk/pcs	36 Stk/pcs	52 Stk/pcs	Sechskantmutter Hexagon nut	DIN EN 24032 M10 – 8.8	
6	4 Stk/pcs	4 Stk/pcs	6 Stk/pcs	6 Stk/pcs	Sechskantschraube Hexagon head cap screw	DIN EN 24014 M8 x 45 – 8.8	
7	8 Stk/pcs	8 Stk/pcs	12 Stk/pcs	12 Stk/pcs	Spannscheibe Conical spring washer for bolted connections	DIN 6796-8-FST	
8	4 Stk/pcs	4 Stk/pcs	6 Stk/pcs	6 Stk/pcs	Sechskantmutter Hexagon nut	DIN EN 24032 M8 – 8.8	
9	2 Stk/pcs	2 Stk/pcs	2 Stk/pcs	2 Stk/pcs	Befestigungswinkel Fixing Bracket	XNBW-G BI 3,0 DIN59232 ST 02 Z275	
10	2 Stk/pcs	2 Stk/pcs	-	-	Befestigungswinkel Fixing Bracket	XNBW-E06 BI 3,0 DIN59232 ST 02 Z275	
11	-	-	2 Stk/pcs	2 Stk/pcs	Befestigungswinkel groß Fixing Bracket	XNBW-E08 BI 3,0 DIN59232 ST 02 Z275	
12	1 Stk/pcs	1 Stk/pcs	1 Stk/pcs	1 Stk/pcs	Stabilisator 50x10x80 stabilizer 50x10x80	HM2471 DIN7735	
13	1 Stk/pcs	1 Stk/pcs	1 Stk/pcs	1 Stk/pcs	Stabilisator 50x10x175 stabilizer 50x10x175	HM2471 DIN7735	
14	1 Stk/pcs	1 Stk/pcs	1 Stk/pcs	1 Stk/pcs	Stabilisator 50x10x270 stabilizer 50x10x270	HM2471 DIN7735	
15	-	1 Stk/pcs	-	1 Stk/pcs	Stabilisator 50x10x365 stabilizer 50x10x365	HM2471 DIN7735	
16	2 Stk/pcs	2 Stk/pcs	3 Stk/pcs	3 Stk/pcs	Stabilisator 30x30x490 Stabilizer 30x30x490	HM2471 DIN7735	

Anzugsdrehmomente / stud torque

Gewindegröße Screw Size	Fertigung Mounting	Prüfung Test
M8	20 Nm	17 Nm
M10	40 Nm	37 Nm
M12	70 Nm	67 Nm