

Montageanweisung
Installation Instructions
Notice d'installation
Istruzioni per il montaggio

Instrukcja montażu
Инструкция по монтажу
安裝說明

MOELLER 

ALPHA **LOVAG**

Ex

 **AWB1210-1457**
Article No: 266165

PKZM4

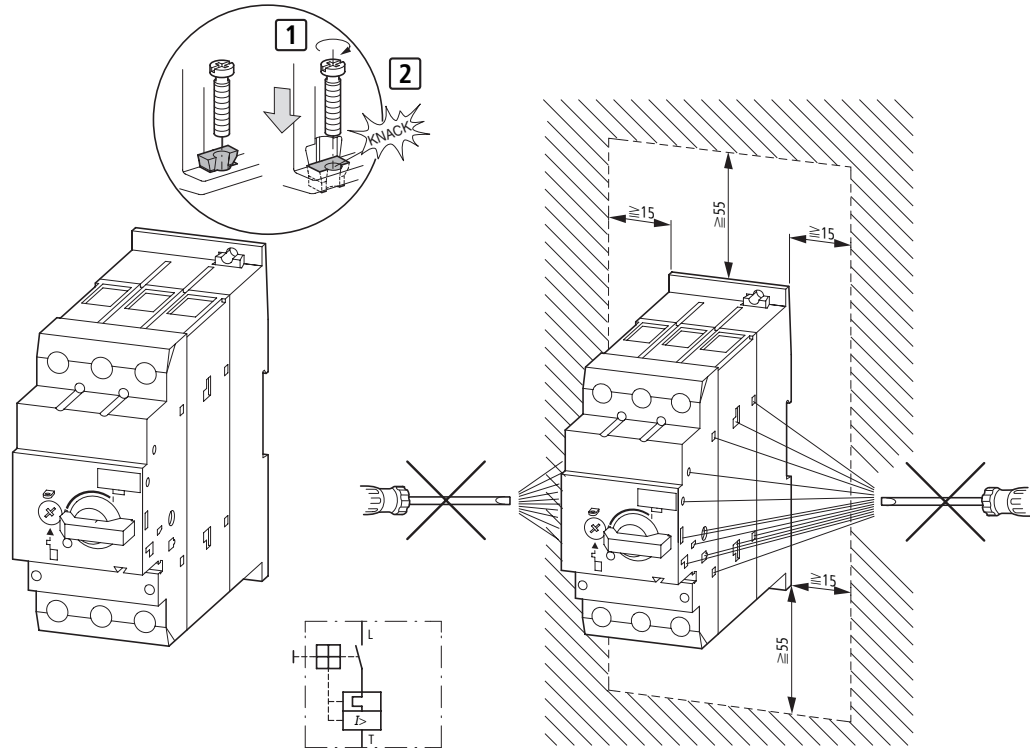

⚠ Lebensgefahr durch elektrischen Strom!
Nur Elektrofachkräfte und elektrotechnisch unterwiesene Personen dürfen die im Folgenden beschriebenen Arbeiten ausführen.

Electric current! Danger to life!
Only skilled or instructed persons may carry out the following operations.

Tension électrique dangereuse !
Seules les personnes qualifiées et averties doivent exécuter les travaux ci-après.

Tensione elettrica: Pericolo di morte!
Solo persone abilitate e qualificate possono eseguire le operazioni di seguito riportate.

Prąd elektryczny! Zagrożenie życia!
Poniższe czynności mogą być wykonywane tylko przez przeszkolony personel.

Электрический ток! Опасно для жизни!
Только специалисты или проинструктированные лица могут выполнять следующие операции.

触电危险!
只允许专业人员和受过专业训练的人员进行下列工作。

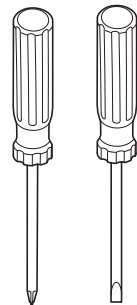





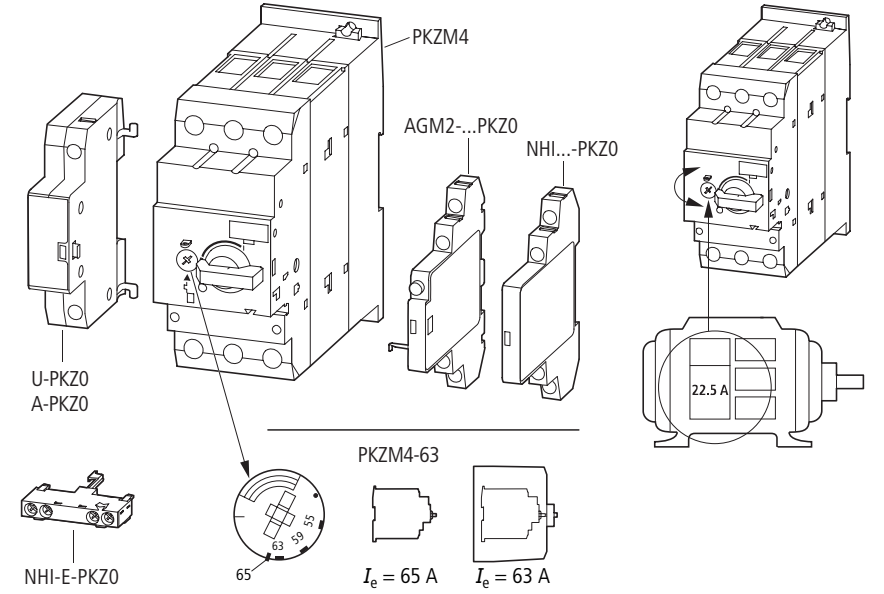

 
Z 2

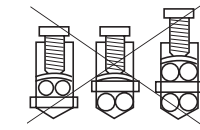
U-PKZ0, A-PKZ0, AGM2-...-PKZ0, NHI...-PKZ0, NHI-E-PKZ0

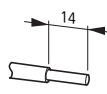

Anschluss technik
Terminations
Technique de raccordement
Tipi di collegamento
Zaciski przyłączeniowe
Техника присоединения
连接技术



	mm ²	mm ²	mm ²	Nm
	0.75 – 16	0.75 – 16	0.75 – 16	3.3
	0.75 – 35	0.75 – 35	0.75 – 25	
	0.75 – 35	0.75 – 35	0.75 – 25	
	16 – 50	16 – 50	16 – 35	
	6 × 9 × 0.8	6 × 9 × 0.8	6 × 9 × 0.8	
	6 × 9 × 0.8	6 × 9 × 0.8	6 × 9 × 0.8	

